

The frogTerminal Installation Manual

Functional Overview and Technical Description

The frogTerminal is a SIP video intercom with multi-factor authentication, decentralised RFID access control, and Bluetooth/IP automation. It supports direct SIP calls, multi-server registration, real-time security alerts, and third-party VMS/SIP integration.

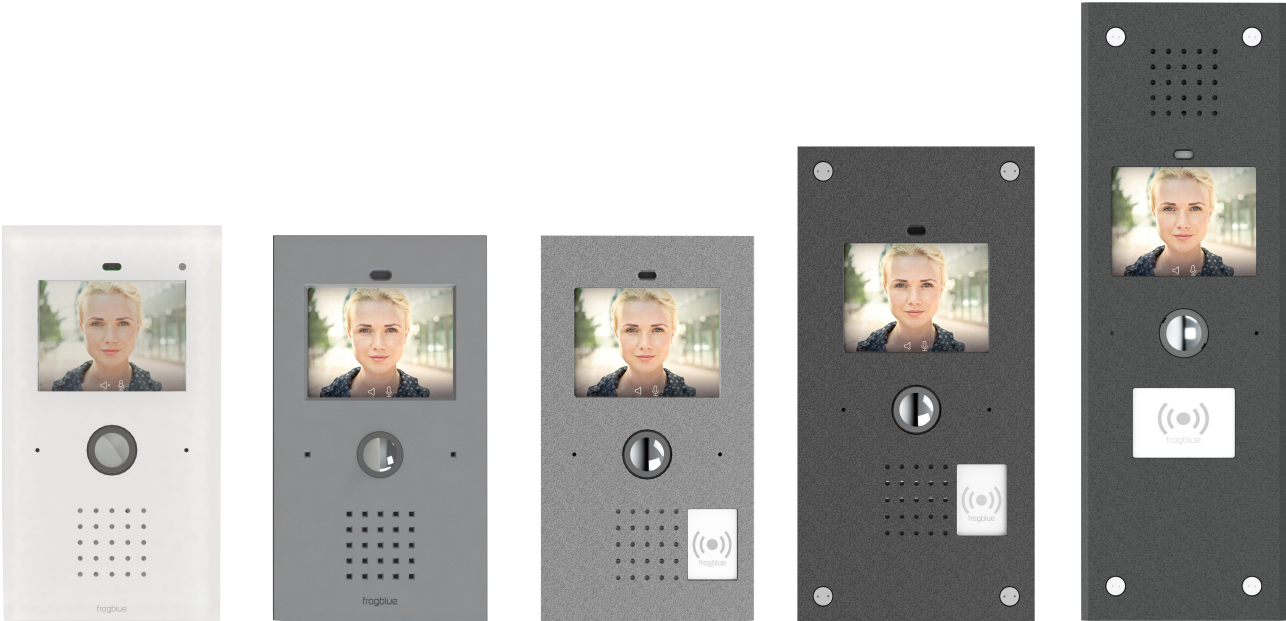

Glas - Line

K - Line

ALU - Line

S2 ALU

S3X

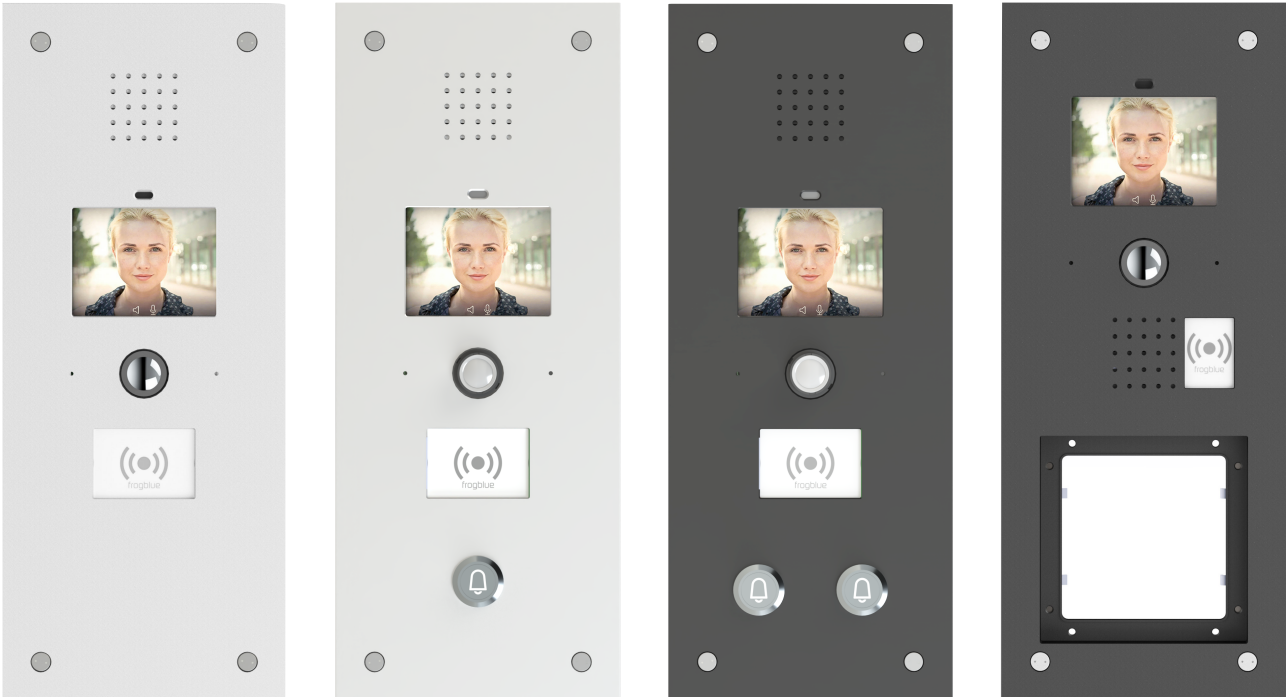

S3 Plus

S3 Plus B1

S3 Plus B2

S3 Vario

The frogTerminal Installation Manual

Functional Overview and Technical Description - V1.0

A. Introduction, System Overview, and Key Features	7
1. Overview	7
2. Key Advantages of the frogTerminal	8
3. Telephony Overview	8
3.1. Worldwide Telephony Standard	8
3.2. Direct Integration of End-point Devices	8
3.3. The frogDisplay	9
3.4. The frogStation	9
3.5. Integration with Telephony Systems	9
3.6. frogSIP App and Calling a Smartphone	10
3.7. Mixed Operation	10
3.8. Video Intercom	10
4. Access Control Overview	10
4.1. Introduction	10
4.2. Decentralised Access Control	11
4.3. NFC/RFID Card Information	11
4.4. Access Functions	11
4.5. Special Access Functions	12
4.6. frogTerminal Access Control Settings Overview	12
4.7. Adding and Blocking RFID Cards	13
4.8. User Display at the Terminal	13
5. Hardware Integrations	13
5.1. Relays and Inputs	13
5.2. IP Link Integration	14
5.3. PIN-Control	14
5.4. USB-C Expansion (USB 2.0 compatible)	14
5.5. Bluetooth Mesh Integration	14
5.6. Vario Module Slot	14
6. Core Features	15
6.1. Access Control Features	15

6.2. SIP Telephony Features	15
6.3. Recording and Event Management Features	15
6.4. SIP Telephony Registration and Costs	16
7. Access Management	16
7.1. Cloud-Based Access Management (frogAccessControl)	16
7.2. Local User Management (frogEasyAccess)	16
7.3. RFID Card Encryption	17
7.4. RFID Card Initialisation and Authentication	17
7.5. Information Stored on the Card	17
7.6. Terminal Settings	18
7.7. Adding and Blocking Cards	18
7.8. User Interface for Access Control	18
8. Commissioning	19
8.1. Setup Process	19
8.2. Initial Setup Requirements	19
9. Advantages & Differentiation	20
10. Additional Features	20
10.1. Multi-Party Doorbell Functionality	20
10.2. Enhanced SIP Telephony Features	20
10.3. Access Control Innovations	21
10.4. Integration with Third-Party Systems	21
10.5. Cloud-Based Management	21
10.6. Local Management Features	21
10.7. Power and Connectivity Options	23
10.8. Time Tracking and Attendance Management	23
B. Technical Installation Manual	24
1. Introduction	24
1.1. Purpose of the Manual	24
1.2 Safety & Compliance	24
1.3 Tools & Equipment Required	24
1.4 System Overview	25
1.5 Installation Workflow Overview	25
1.6 Support & Documentation	25
2. Pre-Installation Requirements	26
2.1 Site Requirements	26
2.2 Power & Connectivity	26

2.3 Dimensions & Weight	27
2.4 Installation Site Assessment	28
2.5 Required Components for Installation	28
2.6 What's in the Box	28
3. Physical Installation Process	29
3.1 Mounting the Device	29
3.1.1 Standard Surface-Mounted Installation	29
3.1.2 Flush-Mounted Installation	30
3.2 Connecting Power & Network	30
4. Initial Setup & Configuration	31
On-Device Touch Screen Installation Wizard	31
4.1 Installation Wizard Step 1: Set Language and Timezone.	31
4.2 Installation Wizard Step 2: Define the Admin PIN.	32
4.3 Installation Wizard Step 3: Set the Web Password / HTTPS Admin Password.	33
4.4 Installation Wizard Step 4: frogBlue Mesh Setup.	34
4.5 Installation Wizard Step 5: Set Device Name.	35
4.6 Installation Wizard Step 6: Set the Home Screen Layout	35
4.7 Installation Wizard Step 7: Connect frogTerminal to your physical or Wi-Fi Network.	36
4.8 Installation Wizard Step 8: Connect to frogCloud	37
4.9 Installation Wizard Step 9: Login to or register for a frogCloud Account	37
4.10 Installation Wizard Step 10: Confirm account activation E-Mail	38
4.11 Installation Wizard Step 11: Create Cloud Project	38
4.12 Installation Wizard Step 12: Create Bell Buttons	38
4.13 Installation Wizard Step 13: Pair with smart device	39
4.14 Start View and View Modes Explained	39
4.15 Installation Wizard Step 14: Start View	41
4.16 Installation Wizard Step 15: Finalise Wizard.	41
5. frogSIP App User Interface	43
5.1. Introduction to frogSIP	43
5.2. Welcome Screen Overview	43
5.3. Create a new frogCloud user account from the frogSIP App	44
5.4. Login to the frogSIP App with an existing frogCloud user account	46
5.5. Main App Interface Overview	48
5.5.1. In-Call Toolbar	49
5.5.2. Logs & Playback Toolbar	50
5.6. Pairing the Terminal with frogSIP App	50
5.7. Call, Playback, and Manage frogTerminal with frogSIP	53

5.7.1. Receiving calls	53
5.7.2. Auto Answer Configuration	53
5.7.3. Initiate calls	54
5.7.4. Access & Event Logs and Playback from a frogSIP call	55
6. Access Control Configuration	56
6.1. Introduction to frogTerminal Access Control	56
6.2. PINs, Access Codes	56
6.3. Graphical feedback for access events	56
6.4. Decentralised Access Control	58
6.5. Card Information	59
6.6. Access Functions	59
6.7. Special Features	59
6.8. RFID Encryption and Zones	60
6.8.1. RFID Encryption and Zones Via Web Browser (Terminal Settings)	60
6.8.2. RFID Encryption and Zones Via On-Device Touch Screen.	63
6.9. Adding and Blocking Cards	64
6.9.1. Adding and Blocking Cards Via Web Browser	65
6.9.2. Adding and Blocking Keys / Cards Via On-Device Touch Screen	68
6.9.3. Reading & Formatting Keys / Cards	70
6.9.4. Via Web Browser (RFID → Access list)	70
6.9.5. Via On-Device Touch Screen	70
7. Telephony Call Destinations Setup	73
7.1. Bell Signs / Ring Buttons	73
7.1.1. Bell Actions: Invite frogSIP user	74
7.1.2. Bell Actions: Direct SIP calls by IP	75
7.1.3. Bell Actions: SIP calls via SIP Server	75
7.1.4. Bell Actions: Send frogMessage	76
7.1.5. Bell Actions: Trigger Relay (hardware)	76
7.1.6. Bell Actions: Start opener sequence	77
7.1.7. Bell Actions: Send IP-Notify	77
7.1.8. Bell Actions: Show image	78
7.2. Authentication call Target	78
7.3. Auto actions	78
8. Camera Settings and Recording Management	79
8.1. Configuring the Camera Image Settings	79
8.2. Optimal Settings for Low Latency & High Frame Rate	80
8.3. Event Recording Settings	80

9. Admin PIN & Function PINs	81
10. Input / Output Settings	82
11. Hardware Settings: Proximity Sensor & Touchscreen Display	83
12. Touchscreen Display Layout	84
13. General Terminal Settings	84
14. Door Control Settings	86
15. On-board Media Settings	86
15.1. Audio files	86
15.2. Image files	86
15.3. Video files	87
15.4. Stream list	87
15.5. Event Pictures	88
16. Configuring the frogTerminal for Automation via frogCast/frogMesh	89
17. Network Configuration	90
17.1. Ethernet or Wi-Fi Setup	90
17.1.1. Network Configuration Via Web Browser.	90
17.1.2. Network Configuration Via On-Device Touch Screen.	90
17.1.3. Ethernet Configuration Via On-Device Touch Screen.	91
17.1.4. Wi-Fi Configuration Via On-Device Touch Screen.	92
17.1.5. Troubleshooting Network Connection Problems	92
17.2. SIP Server Registration	93
17.2.1. SIP Basics	93
17.2.2. SIP Setup via Web Browser	94
17.3. Custom root certificates	95
18. Integration with Third-Party Video Systems	97
18.1. HTTPS or Web Integration - Plain MJPEG stream	97
18.2. RTSP Settings	97
18.3. RTSP Stream Integration	99
18.4. Integration with MOBOTIX MxManagementCenter	103
19. Advanced Integration and API Features	107
19.1. Custom Display Interfaces	107
19.2. Time Tracking and Attendance	107
20. Maintenance and Troubleshooting	108
20.1. Firmware Updates	108
20.2. System Control - Manage configuration files, Reboot, and Factory Reset	108
1Reset system to factory defaults via Web interface	108

A. Introduction, System Overview, and Key Features

1. Overview

The **frogTerminal** offers functionality that goes far beyond a traditional video intercom system. Its key feature is its network connection and direct utilisation of the global IP telephony standard SIP, without requiring an additional box. This enables all SIP-compliant devices to be called directly without a server or cloud.

In commercial **multi-tenant scenarios**, tenants often have their own IP telephony systems with integrated SIP servers. In such cases, intercom systems typically connect to these systems via external calls. The **frogTerminal**, however, can register simultaneously as an **extension** with multiple SIP servers, optimising the use of telephony system features.

The integrated **8-megapixel camera** with hemispheric optics provide for a 180° panoramic view, all actions at the terminal can trigger a recording. It also integrates with video management software like MxMC® and supports real-time, full HD video streaming via RTSP/H.264.

Connection options for the frogTerminal include:

- 1-Gbit Ethernet with **Power over Ethernet** (PoE) via the network cable.
- 12-24VDC (12W) (reverse-polarity protected)
- 24VAC (12W)

For simple applications, the integrated relay can directly handle door unlocking, 2 input ports enable direct connection to external doorbell buttons or magnetic door contacts.

The **integrated touch display** allows for the virtual design of doorbell labels. Alternatively, a party can be discreetly dialled using an apartment number. General PIN codes can also be entered for door unlocking or special functions.

A **smartphone** call is initiated as a standard phone call when the doorbell rings. This requires registration in frogblue's cloud (with SIP server) and the installation of the frogSIP app on the smartphone.

The **integrated RFID reader** facilitates access control and time tracking. By combining RFID with a PIN entered via the display, the system enables two-factor authentication. Access control can be further restricted using customised weekly schedules. For enhanced security, three-factor authentication can also be enabled, incorporating an automatic phone call as an additional layer of verification. This three-factor authentication can be configured to activate based on a timetable, such as after hours, ensuring stricter access control during high-risk periods.

The frogTerminal supports multi-party and multi-tenant capabilities, as each party can individually configure its access parameters. **Third-party hardware**, such as barrier systems or KNX-based lighting controls, can be integrated via IP commands. Frogblue building control components are directly connected via Bluetooth, allowing simple deployment of frogblue modules for functions like gate control or door unlocking. DALI lights are supported directly with our DALI frog. For a detailed overview of integration options, refer to the frogblue API documentation and our competitor analysis.

The commissioning process is guided by a user-friendly wizard, which walks the administrator through the necessary steps to configure the terminal.

2. Key Advantages of the frogTerminal

- **Integrated 8 MP Camera** - Provides visual verification and 180° panoramic recordings.
- **Built-in Video-SIP Telephony** - Enables remote operation by reception or security staff.
- **Advanced Multi-Factor Authentication** - Supports multi-factor authentication, including RFID, PIN, video verification call, and advanced integrations.
- **Global Video Calls** - Directly connects to smartphones or SIP phones worldwide.
- **Real-Time Security Alerts** - Sends call notifications for unauthorised access attempts or restricted user access.
- **Flexible Multi-Terminal Access Management** - Supports up to 9 access zones, even without an IP connection.
- **Optional User Group Management** - Centralised storage in the frogCloud (in development).
- **Seamless Hardware Integration** - Supports IP or Bluetooth-based devices for light control, gate opening, and more.
- **Standalone Operation** - No additional hardware or external computer systems required.
- **High-Speed Connectivity** - 1-Gbit network connection with PoE Class 3 or Wi-Fi support (also compatible with 24V AC/12V DC power).
- **Energy-Efficient Design** - Power consumption ranges from 5 to 8 watts.

3. Telephony Overview

3.1. Worldwide Telephony Standard

The frogTerminal utilises the international **telephony standard SIP** for video and audio communication. This makes all SIP-compliant endpoints accessible directly, without additional hardware. Nearly all modern telephone systems are based on this standard, facilitating the easy integration of third-party devices.

Typically, all devices register with a **SIP server** that handles call routing. This SIP server can be installed locally or made available over the internet for worldwide telephony.

The frogTerminal is designed to support local telephony without relying on an internet connection, enabling on-site communication with **no cloud** required. For connecting multiple company locations, a virtual private network (VPN) offers a secure private solution. Only when integrating independent locations or smartphones without VPN into the system, an internet-based cloud-service with SIP server becomes essential. To make this easy, frogblue provides our own SIP cloud with automated configuration options, hosted in a secure German data centre.

3.2. Direct Integration of End-point Devices

IP telephones, such as those from Grandstream®, can be called directly by the frogTerminal without additional components. A SIP server is not required as the **Direct SIP Call functionality** is used, provided the device is reachable via an IP address.

For small setups, the simplest configuration consists of a frogTerminal and a SIP desktop phone. This eliminates the need for SIP server hardware and management.

3.3. The frogDisplay

With a simple software update, the existing **frogDisplay** can be upgraded to function as an indoor station. It connects via **Wi-Fi** and operates on **100-240V power**. The updated software enables **automatic configuration** with the **frogTerminal**, and a simple toggle switch allows it to function as a **doorbell**.

Currently, devices are added manually to the **bell buttons** via their **IP address**. An upcoming software update will introduce automatic configuration.

The **frogTerminal** offers 4 modes for auto-configuring Displays (currently in development):

1. **Bell Mode:** All discovered Displays are automatically grouped under a standard doorbell label in a cyclical process.
2. **Room Mode:** The Display's assigned room name (e.g., "Foyer") is used as the doorbell label. If multiple Displays share the same room name, they are grouped under a single bell button.
3. **Name Mode:** Displays can be registered with a custom name (e.g., "Tom Smith" or "Reception"), which is automatically assigned as the doorbell label. Displays with the same name are grouped together under one label.
4. **Terminal Mode:** The name entered in the Terminal is used as the doorbell label. If no name is configured, the system defaults to the Display's name, and if that is unavailable, it falls back to the room name.

3.4. The frogStation

The **frogStation** is a frogblue device that serves as the primary remote station for the **frogTerminal**. Installed, for example, in an apartment, it provides a user interface for interacting with the **frogTerminal** at the entrance. It is similar in design to the **frogTerminal**, but without a camera module. Unlike the **frogDisplay** it features enhanced audio capabilities for superior sound quality and supports both Wi-Fi and wired network connectivity with PoE for increased reliability.

It features **2 switching inputs** and a **24V/1A** relay for external controls, enabling seamless integration with additional systems.

Thanks to its **enhanced mechanical** and **acoustic design**, the **frogStation** delivers **superior** and **louder sound quality** compared to the **frogDisplay**.

3.5. Integration with Telephony Systems

IP telephony systems typically feature a PBX with integrated SIP server for registering devices and routing calls. The **frogTerminal** can register with such SIP servers, functioning as an extension of existing telephone systems.

In multi-tenant environments, tenants often rely on separate telephone systems. The solution: the **frogTerminal** supports simultaneous registration and operates with multiple SIP servers at the same time, seamlessly integrating across multiple telephony systems.

3.6. frogSIP App and Calling a Smartphone

Smartphone calls require push notifications from the device manufacturer to wake the phone and launch the telephony app. To facilitate this, frogblue operates a dedicated telephony cloud including SIP server, ensuring reliable delivery of the required push notifications.

The smartphone must have the **frogSIP App** installed, which receives calls in the same familiar way as regular phone calls. This setup is free to use and, apart from email verification, remains anonymous.

frogSIP is engineered for **seamless integration** with **frogTerminal** and offers a host of advanced features:

- **Seamless Device Pairing:** Easily connect and pair devices for a smooth setup experience.
- **Integrated Automation:** Fully integrated into the frogblue automation system, frogSIP streamlines centralised management.
- **Direct Access & Log Control:** Gain immediate control over access permissions, call logs, recordings, and playback.
- **Multi-Door Support:** Manage multiple doors effortlessly, enhancing both security and convenience.

To connect personal devices via the internet, frogCloud is essential. The frogTerminal automatically registers with the cloud when configured by the Installer or System Administrator.

3.7. Mixed Operation

The frogTerminal supports simultaneous operation of all modes:

- Direct SIP calls to local devices
- Registration with multiple telephony systems (using various SIP servers)
- Smartphone calls via the frogCloud

3.8. Video Intercom

With an integrated camera, audio, and display, the **frogTerminal** offers comprehensive **video intercom** capabilities. In contrast, the frogStation and frogDisplay support video reception but are optimised for audio-only transmission. New features such as announcements and baby monitor functions are currently under development.

4. Access Control Overview

4.1. Introduction

The frogTerminal offers convenient, time-controlled and multi-factor access control using PIN Codes, RFID cards, and Phone Calls. A **cloud** or network **connection** is **not required** for these functions.

The terminal supports the **Mifare DESFire EV2** international card standard. RFID cards or key tags only need to be configured on one frogTerminal, and they can be used across **all terminals** in the same **project** with **no additional setup**. A network connection is not required, though it simplifies administration for remote management.

4.2. Decentralised Access Control

With frogblue, user data is stored directly on RFID cards or key tags. Terminals read the data during card scans, eliminating the need for network or cloud connections.

For all terminals in a project to read the encrypted data, they must share the same encryption settings, which include:

- A 10-digit RFID code
- Project Timestamp

Changes to user data—such as updated PINs or access permissions—only need to be made on one terminal (for example, at the main entrance). The system then automatically updates the card with the new data the next time it is used, ensuring a seamless update process. Blocking a card follows the same process.

Note: Synchronisation via IP network and locally via Bluetooth + a cloud-based access management system with time tracking is currently in development.

4.3. NFC/RFID Card Information

The RFID card stores all essential user access data, including:

- Name, first name, and personnel number
- Issue date
- Validity period (start date/time to end date/time)
- Personal PIN code for access
- Weekly access schedules
- Up to 9 access zones

Each **frogTerminal** reads and interprets the card's contents whenever it is scanned. For example, changes to PINs or access schedules are **automatically updated** upon reading the card.

The terminal logs the card content, including timestamps for each operation. User information and access times can be viewed directly on the terminal display or via the frogSIP App. If a network connection is available, these logs can be reviewed remotely via a web browser.

4.4. Access Functions

RFID cards or key tags define user-specific access rules. These include PINs, weekly schedules, and access zones. Additional terminal-specific settings can override or adjust these rules (Access Control → Terminal Settings):

- PIN Requirements
 - Certain doors can be configured to allow access without requiring the user's personal PIN code e.g. for internal doors. (PIN code Source: "NONE")
 - Alternatively, a door can be secured with a terminal-specific code. This PIN applies to all users equally, overriding personal PINs. (PIN code Source: "TERMINAL")

- Time Restrictions
 - Access times can be based on the individual card schedule or configured globally for all users at the terminal (Time Table Source: "Card" or "TERMINAL").
 - Time restrictions can also be disabled entirely for specific terminals (Time Table Source: "NONE").

4.5. Special Access Functions

RFID cards can store additional features:

- Automatic SIP Phone Call (SIP URI)
- A phone number which can be dialled automatically when the card is presented.
- IP Link - automatically trigger or integrate external systems (e.g., time tracking or special functions).

These features allow RFID cards to act as function triggers rather than just user-specific access tools. For instance, an RFID card labeled "Storage Access" could be shared as needed.

Special Function Settings at Terminals have 3 general options:

1. **NONE:** Special functionality is disabled.
2. **CARD:** The function stored on the RFID card is activated.
3. **Terminal:** The function stored on the Terminal is activated in place of that on the Card.

4.6. frogTerminal Access Control Settings Overview

The settings of the terminal can be configured via the on-screen display and remotely through the web interface. The following key access parameters must be set during initialisation:

- RFID Code: 10-digit encryption code for cards (hashed for security)
- Project Date: Shared date for card encryption across all devices in the project
- Project Number: Shared ID for project identification across all devices in the project (1-32,767)
- Zone: Assign the terminal to one of 9 access zones
- PIN Code Source: None, Card, Terminal
- Terminal PIN Code: 6-digit Access Code
- Time Table Source: None, Card, Terminal
- Terminal Table: Time Table for Access at this Terminal only
- Time Table Exception: None, PIN, or Request e.g. for access outside regular schedules
- Authentication Call: Never, Card, On Exception, Always
- URL Source: None, Card, Terminal - The source for the Web-hook URL
- Terminal URL: Web-hook URL to for realtime integration of access events
- Date of Issue: Minimum Issue Date - Cards issued before this date are invalid

For different levels of security at various terminals, the following settings can be applied:

- NONE: Function is not required, e.g., access without PIN verification at specific Terminal.
- CARD: The function parameter is read from the RFID card.
- STATION: The parameter is retrieved from the terminal itself - e.g., a global PIN for all users at a specific location or direct integration at this specific access point i.e. time and attendance, worksite management, nurse call, or logistics systems.
- PIN Authentication: Access can occur without an RFID card, using only a PIN stored in the terminal.

4.7. Adding and Blocking RFID Cards

Adding Cards:

A user can self-register an RFID card if an authorised station confirms the action via a SIP phone call. The user enters their personal details (e.g., name, personnel number), while an administrator approves the data and sets additional parameters.

Blocking Cards:

Blocking a card must be performed locally on all terminals, as each maintains its own negative list of blocked cards. Remote blocking via the web interface is possible.

Note: In a cloud-based solution, blocking is centralised and does not require action at each terminal.

4.8. User Display at the Terminal

The terminal displays the following for users:

- Large bell icon: For unauthenticated users
- Keypad menu: For PIN entry
- Settings menu: For admin access
- Date and time display: Helps identify incorrect terminal settings
- Time tracking options: "Check-in," "Break," and "Check-out" menus for time tracking

Note: As an example the ODOO ERP system includes a time tracking module, an integrated solution with frogblue and ODOO is currently in development.

5. Hardware Integrations

5.1. Relays and Inputs

The frogSIP terminal includes a potential-free relay output (24V/1A), which can directly control a door lock when connected to an external power supply (12V or 24V).

It also features 2 input ports that can be directly connected to buttons or magnetic contacts without requiring additional power supply. These inputs can be configured for:

- Triggering a doorbell via an external button to call a SIP endpoint
- Automatic calls triggered by sensors (e.g., motion detectors or light barriers)

- Sending signals via Bluetooth Mesh (e.g., for lighting control) or IP
- Monitoring door status with magnetic contacts (open/closed); with the second input, it can register whether the door is locked.

5.2. IP Link Integration

The terminal supports activating external systems via IP links. For example, scanning an RFID card or pressing a button can trigger functions such as:

- Opening a parking barrier
- Raising a roller door
- Triggering video recordings on an external camera

5.3. PIN-Control

Preconfigured Function PIN codes linked to specific IP commands or Mesh messages can be used to control external systems or hardware. Function PINs can be shared among all users and used to control for example: lighting or gates, security cameras, or third-party software.

5.4. USB-C Expansion (USB 2.0 compatible)

The terminal's USB-C port enables connections for frogblue hardware expansions, including:

- Internal hardware (e.g., sensors, mechanical keypads)
- External USB devices (e.g., local data storage or additional control modules)

5.5. Bluetooth Mesh Integration

The terminal includes a frogblue Bluetooth Mesh interface for integration into frogblue projects. Initially, it supports the simple integration of modules without using the ProjectApp. In later updates, it will fully integrate into frogblue projects.

Supported modules include:

- frogEntry: For door opening (3x inputs, 2x 12V outputs)
- frogRelay-LV: 24V version with 2 outputs and 2 inputs, suitable for gate control
- frogDim: For lighting control

5.6. Vario Module Slot

The frogSIP Terminal Vario includes a dedicated slot for a Vario module, enabling the integration of third-party modules such as:

- Time tracking systems
- Fingerprint readers

At this stage, integration is supported only for the Siedle 1 and 2 range via direct switching inputs/outputs.

These modules can function independently or be linked to the terminal's hardware to trigger predefined actions.

6. Core Features

6.1. Access Control Features

The frogTerminal supports multi-party doorbell functionality, enabling calls to SIP endpoints or smartphones for access control. Two-way video and audio communication is possible with hands-free operation. Access functions include:

- Doorbell and manual door unlocking: Calls to smartphones or SIP phones with rerouting outside access times.
- PIN-controlled access: Shared or user-specific PINs with individual schedules.
- RFID cards or tags (DESFire EV2 standard): Weekly schedules supported.
- Two-factor authentication: RFID card + personal PIN with schedules.
- Three-factor authentication: RFID card + PIN + visual verification via phone call.
- Visual verification via phone call: Outside regular access times.
- frogKey (Bluetooth Transponder): For vehicle-based access with time restrictions.

6.2. SIP Telephony Features

The frogSIP terminal features a globally standardised SIP telephony module with two-way video support over the network. Key benefits include:

- Direct compatibility with SIP endpoints (e.g., Grandstream IP video phones)
- High video and audio quality without external conversion modules, avoiding quality loss
- Direct IP calling without a SIP server for simpler setups
- Multi-SIP server support for complex installations
- Smartphone integration via the frogSIP app and frogblue SIP server, hosted in a secure German data centre
- The frogSIP app offers direct integration of frogblue functions such as:
 - Door unlocking
 - Light control
 - Camera adjustments
 - Recording access and playback

Third-party SIP apps like LinPhone, 3CX, Bria, etc. can also be used but may require DTMF key-based operation for additional functions.

6.3. Recording and Event Management Features

The terminal can trigger recordings for every action. Features include:

- Full-resolution raw image storage (4 MB) for post-processing and zooming
- Configurable pre- and post-alarm snapshots
- Detailed metadata for every recording, including:
 - RFID card information
 - Video feed parameters (e.g., exposure settings)

6.4. SIP Telephony Registration and Costs

Registration of smartphones is quick and easy using a QR code generated by the terminal. This automatically configures the doorbell to route calls to the smartphone.

A single smartphone registration per terminal is free and anonymous, requiring only email confirmation within 12 hours. Advanced features like external cloud storage or additional frogblue SIP users are billed monthly.

7. Access Management

7.1. Cloud-Based Access Management (frogAccessControl)

For large networks with multiple terminals at different locations, centralised administration via the cloud-based frogAccessControl is the optimal solution. This system enables:

- Instant updates to all terminals with a single action
- Immediate blocking of RFID cards across all terminals

This cloud solution is currently in development and builds upon the functionality of frogControl and the frogSIP server, integrating a database for centralised management.

7.2. Local User Management (frogEasyAccess)

For smaller setups without intensive administration, the frogEasyAccess solution offers simple and efficient user management without requiring cloud integration. This approach:

Allows RFID cards configured at one terminal to work seamlessly on others within the same project, without additional setup.

Stores user data directly on RFID cards, including:

- PIN code
- Weekly schedules
- Zone authorisations
- All terminals within a project must share the same RFID encryption settings (RFID code and project date) for compatibility.

Key Benefits:

- Cards initialised at one terminal are automatically functional on others within the same project.

- Terminals can be grouped into up to 9 access zones, with cards able to be assigned to multiple zones.
- Security settings can be adjusted for each terminal (e.g., disabling PIN requirements at some terminals).
- Multi-factor authentication can be enabled for additional security, e.g. requiring video verification via SIP phone call.

Note: An IP network or Bluetooth Mesh is recommended to ensure time and date synchronisation across terminals.

7.3. RFID Card Encryption

RFID cards are encrypted for security. Terminals in a project must use the same encryption settings, which are derived from:

- A 10-digit **Master Key**
- The project's issue date
- The project's identifier 1-32,767

This combination generates a unique key through a hash algorithm. Multiple projects can coexist without conflicts, as the project date & identifier ensures uniqueness even if the Master Key is accidentally reused.

7.4. RFID Card Initialisation and Authentication

When initialised at a terminal, RFID cards store:

- User details (name, personnel number)
- Access information (PIN, zones, weekly schedules)

Terminals read the card data for local, decentralised access decisions, even without a network connection. This eliminates the need for manual registration at every terminal.

Remote management of user data is also possible through:

- The terminal's web interface
- The frogSIP app on a smartphone

This provides the foundation for enhanced cloud functionality.

7.5. Information Stored on the Card

RFID cards contain the following information:

- User details: Name, first name, personnel number
- Validity period: Start and end dates
- Zone assignments (up to 9 zones)
- A 6-digit personal PIN
- Weekly access schedules

- IP link for triggering functions over the network
- SIP phone number for automatic calls upon card scanning
- Terminal ID and issue date of the initialising terminal
- An AllStation flag allowing the card to work on all terminals within the project
- Customisation per terminal: Specific parameters (e.g., PIN requirements or access schedules) can be adjusted at individual terminals without modifying the card.

7.6. Terminal Settings

Configuration data for Terminals includes:

- RFID Code: Encryption code shared across the project.
- Project Date: Used with the RFID code to generate encryption keys.
- Authentication Modes: PIN, CARD, TERMINAL, CLOUD, PIN request, CARD request.
- Zone Assignment: One of 9 zones for the terminal.
- PIN Source: NONE, CARD, TERMINAL, or CLOUD.
- Access Time Source: NONE, CARD, TERMINAL, or CLOUD.
- Exception Handling: NONE, PIN, CLOUD, or REQUEST (e.g., for emergency access).
- Issue Date: Only cards issued after this date are valid.

7.7. Adding and Blocking Cards

Users can add RFID cards themselves with approval via a SIP phone call from an authorised station.

Adding RFID Cards:

- Admin add locally.
- Admin over third party RFID reader (future / typical hotel solution / Web/Cloud).
- In development - frogCast Mesh (IP distribution of access rules).

Blocking RFID cards:

- Can be done locally at all terminals.
- Can be performed remotely via the terminal's web interface.
- Block all with validity time.

In a cloud-based system, blocking occurs centrally and does not require individual terminal updates.

7.8. User Interface for Access Control

The terminal displays user-friendly options for:

- Doorbell icons for unauthenticated users.

- Keypad menu for PIN entry.
- Settings menu for admin access.
- Date and time display to identify incorrect settings quickly.
- Time tracking options (e.g., "Check-in," "Break," "Check-out") for attendance management.

8. Commissioning

8.1. Setup Process

The frogTerminal features an intuitive setup wizard to guide administrators through the configuration process step-by-step. The wizard simplifies the initialisation of key settings such as:

- Network and power connections.
- SIP registrations.
- RFID encryption parameters.
- Access zones and schedules.

Once the initial configuration is complete, administrators can further refine settings via the terminal's web interface or touch display.

8.2. Initial Setup Requirements

During commissioning, the following parameters must be configured:

Network Configuration: IP address, PoE or Wi-Fi settings

SIP Registration: Integration with SIP servers or enabling direct SIP calls

RFID Encryption Settings:

- 10-digit RFID encryption code.
- Project date (shared across all terminals in the project).
- Zones and Time Schedules.
- Assignment of the terminal to one of the 9 zones.
- Configuration of weekly access schedules.

PIN and Access Settings:

- Default PIN modes: NONE, CARD, TERMINAL, or CLOUD.
- Time schedule source: NONE, CARD, TERMINAL, or CLOUD.
- Exceptions handling (e.g., emergency access): NONE, PIN, or REQUEST.

Physical Setup:

- Connect power (PoE or external supply).
- Verify input/output connections for relays, buttons, or sensors.

9. Advantages & Differentiation

The frogTerminal offers several advantages over competing access terminals:

- **Integrated 8 MP Camera:** Provides visual verification and 180° hemispheric recordings.
- **Integrated Video-SIP Telephony:** Enables remote operation by receptionists or security staff.
- **Three-Factor Authentication:** Combines RFID card, PIN, and phone call (with video).
- **Direct Worldwide Video Calls:** To smartphones or SIP phones (Mac and PC support in progress).
- **Call Notifications for Unauthorised Access:** Alerts for incorrect PINs or restricted users.
- **Simple Multi-Terminal Management:** Access management across up to 9 zones, even without an IP network.
- **Group Management with Centralised Storage:** Available through the frogCloud in Phase 2.
- **Integration with External Hardware:** IP or Bluetooth-based control for lighting, gates, or barriers.
- **No Additional Hardware Required:** Eliminates the need for external computers or servers.
- **High-Speed Network Connectivity:** 1-Gbit Ethernet with PoE or Wi-Fi support (24V AC/ 12V DC power).
- **Low Power Consumption:** Only 5-8 watts.

10. Additional Features

10.1. Multi-Party Doorbell Functionality

The frogSIP terminal supports multi-party configurations, allowing different tenants or users to utilise:

- Personalised doorbell labels on the touch display
- Apartment dialling with custom or predefined numbers
- Integration of external buttons for specific calls or triggers

10.2. Enhanced SIP Telephony Features

The frogSIP terminal leverages the SIP telephony standard for robust communication:

- **Direct IP Calling:** Eliminates the need for a SIP server in small setups, reducing hardware costs and administrative overhead.
- **Multi-SIP Server Registration:** Supports registration with multiple SIP servers simultaneously for complex systems or multi-tenant scenarios.
- **Smartphone Integration via frogSIP App:** Available for both iOS and Android. Facilitates calls to smartphones with integrated door control options.
- **Desktop Compatibility:** The frogSIP app is available for Mac. PC support is under development.

- Browser-based SIP functionality (similar to WhatsApp) is in progress, requiring no browser plugins.
- Recording and Event Management: Full-resolution recordings triggered by actions at the terminal.
- Configurable pre- and post-event snapshots for detailed analysis.
- Metadata stored with each recording, including RFID card usage and current video settings.

10.3. Access Control Innovations

The frogTerminal enables time-controlled access using RFID cards, PINs, or phone calls.

Advanced features include:

- 2-Factor Authentication: RFID card + PIN for enhanced security.
- 3-Factor Authentication: RFID card + PIN + video call verification for critical access points.
- Event-Based Notifications: Alerts for failed access attempts, misuse, or specific user access events.

10.4. Integration with Third-Party Systems

The frogSIP terminal supports integration with external hardware and systems via:

- IP Links: For controlling external devices like parking barriers or lighting systems.
- Bluetooth Mesh: For seamless integration with frogblue building control modules, such as:
- frogRelay: For gate control.
- frogDim: For lighting management.
- Hardware Expansion via USB-C: Supports internal and external hardware extensions (e.g., motion sensors, additional cameras, or keypads).
- MQTT and JSON REST API for advanced software integrations and future proofing.

10.5. Cloud-Based Management

The frogTerminal is designed for seamless integration with the frogCloud for advanced features like:

- Centralised user and group management.
- Synchronised updates across all terminals in a system.
- Remote management and blocking of RFID cards in real-time.

10.6. Local Management Features

For smaller systems, the frogEasyAccess solution offers:

- Decentralised user management with encrypted data stored on RFID cards.

- No reliance on the cloud for functionality.
- Compatibility across terminals within the same project without re-registration.

Why No Reliance on the Server or Cloud for Functionality?

One of the key advantages of a **decentralised access control system** that stores access data, time rules, and permissions directly on the card is that it eliminates the need for **server-based authentication** or continuous server connectivity. Here's why this is beneficial:

1. Works Independently of Network Connectivity

- Traditional cloud-based access control systems require a stable **connection** for user authentication, permission verification, and logging access events.
- In contrast, a **decentralised system functions entirely offline**, meaning users can still access secure areas even if there is an **internet outage or network disruption**.

2. Eliminates Single Points of Failure

- **Cloud-dependent systems introduce risk**: if the cloud server is down or experiencing latency, access can be **delayed or denied**.
- By storing data **locally on the card**, users are not affected by **server downtime**, network failures, or cybersecurity incidents targeting the cloud infrastructure.

3. Enhanced Privacy & Data Security

- Cloud-based access systems require centralised data storage, making them a target for cyberattacks, data breaches, or unauthorised access.

4. Faster Authentication Times

- With **on-card authentication**, the terminal reads the card **instantly**, removing **network latency** and significantly improving access speed.

5. Seamless Multi-Terminal Access Without Re-Registration

- With centralised or cloud-based authentication, every terminal must **sync** with the server to validate user credentials.
- A decentralised system allows terminals within the same project to recognise a card automatically, without requiring user re-registration or database synchronisation.

Key Takeaway: By **storing access data on the card**, we achieve a system that is:

- **Resilient**: Works even when the cloud is down
- **Secure**: No centralised database to hack
- **Fast**: No network delays
- **Private**: No personal data transmitted over the internet
- **Independent**: No vendor lock-in or reliance on cloud services

This approach ensures **maximum uptime, reliability, and seamless access across multiple terminals**, making it a superior alternative to cloud-dependent access control systems.

10.7. Power and Connectivity Options

The frogTerminal supports multiple power and connectivity options for flexible installations:

- Power over Ethernet (PoE): Simplifies wiring and reduces the need for separate power supplies.
- Wi-Fi Support: For installations without network cabling.
- 12V DC or 24V AC Power: Alternative power options for diverse environments.

10.8. Time Tracking and Attendance Management

The terminal can be configured for time tracking, enabling users to:

- Check-in and check-out for attendance purposes.
- Record break times.
- Export attendance data to compatible systems like the ODOO database.

B. Technical Installation Manual

1. Introduction

1.1. Purpose of the Manual

This manual provides step-by-step instructions for the installation, commissioning, and configuration of the frogTerminal. It is intended for professional installers, system integrators, and technical personnel responsible for deploying and maintaining the system.

The manual covers mounting, wiring, network setup, access control, SIP telephony, video and recording management, as well as advanced functions and integrations.

1.2 Safety & Compliance

Before installing and configuring the frogTerminal, read the following safety guidelines:

- **Electrical Safety:** Disconnect power before performing any wiring or maintenance.
- **Secure Installation:** Use strong passwords or keys for administrators. Ensure both side locking screws are secured. Consider flush-mount models to prevent unauthorised removal.
- **Compliance:** Ensure that the installation site meets all local electrical and safety regulations.

1.3 Tools & Equipment Required

To complete the installation, ensure the following tools and materials are available:

- Drill and appropriate drill bits for mounting.
- Security bit or screwdriver (can be ordered separately - frogTerminal TM-Sec).
- Level and measuring stick / tape.
- Network cable (Cat 5e or higher, if using Ethernet).
- 8-Pin Phoenix Connector for network cable connection (included in box).
- PoE Switch/Injector or 12V-24V DC (or 24V AC) power supply.
- RFID keys, cards, or tags for testing access control functions.
- Laptop or tablet device for web-based configuration.
- Tablet (or Laptop + frogLINK) with frogProject App installed for configuring automation via Bluetooth (Recommended: iPad running iOS 12.1 or later).
- Smartphone or device with frogSIP App Installed for testing call functions.
- Smartphone or device with frogControl App Installed for remote control and cloud automation functions.

Note: A frogDisplay is currently required for remote control via the cloud when paired with the frogControl App for automation. Local control works directly as always.

Terminal support is in development and will be included in a future software update.

1.4 System Overview

The frogTerminal is a networked access control and communication device that integrates SIP telephony, video intercom functionality, credential based access control, and third-party system integrations.

Key features include:

- **SIP Telephony:** Direct IP calling and multi-SIP server registration for advanced multi-tenant setups.
- **Access Control:** Decentralised credential management with encryption via PINs, Phone/NFC, RFID.
- **Multi-Factor Authentication:** RFID, PIN, Phone, video verification, and more via integrations.
- **Mesh Integration:** Provides infrastructure-free communication using frogCast®, frogblue's unified BLE + IP Mesh technology.
- **Cloud & Local Management:** Supports remote administration via frogCloud and standalone operation for instant failover redundancy or completely private setups with VPN support.

1.5 Installation Workflow Overview

Installation and commissioning of the frogTerminal follow these key steps:

- **Pre-Installation Planning:** Assess the mounting location, power, and network requirements.
- **Physical Installation:** Securely mount the device, connect power, and network cables.
- **Initial Setup:** Use the touchscreen wizard to configure initial admin credentials and network settings.
- **System Configuration:** Set up access control, SIP telephony, and integrations via the touchscreen or web interface.
- **Testing & Verification:** Ensure all functions, including door control and intercom, operate correctly.
- **Final Deployment:** Secure and backup configuration settings and inform end-users of operating procedures.

1.6 Support & Documentation

For further assistance, refer to:

- The latest firmware updates and documentation at frogblue.com
- Technical support via **authorised partners** or your nearest **frogblue CompetenzCenter**.
- Online troubleshooting and FAQs.

2. Pre-Installation Requirements

2.1 Site Requirements

Before proceeding with the installation, ensure the following conditions are met:

- **Mounting Surface:** Ensure the surface is stable and suitable for securely mounting the frogTerminal.
- **Power Availability:** Confirm the availability of PoE (Power over Ethernet) or a 12V-24V DC power source.
- **Network Connectivity:** A stable network connection must be available via Ethernet or Wi-Fi for full functionality. Standalone Automation & Access Control however, is supported even without network connectivity.

2.2 Power & Connectivity

The frogTerminal supports multiple power, I/O, and network configurations with connectors for power, inputs, output, network, and additional expansion options:

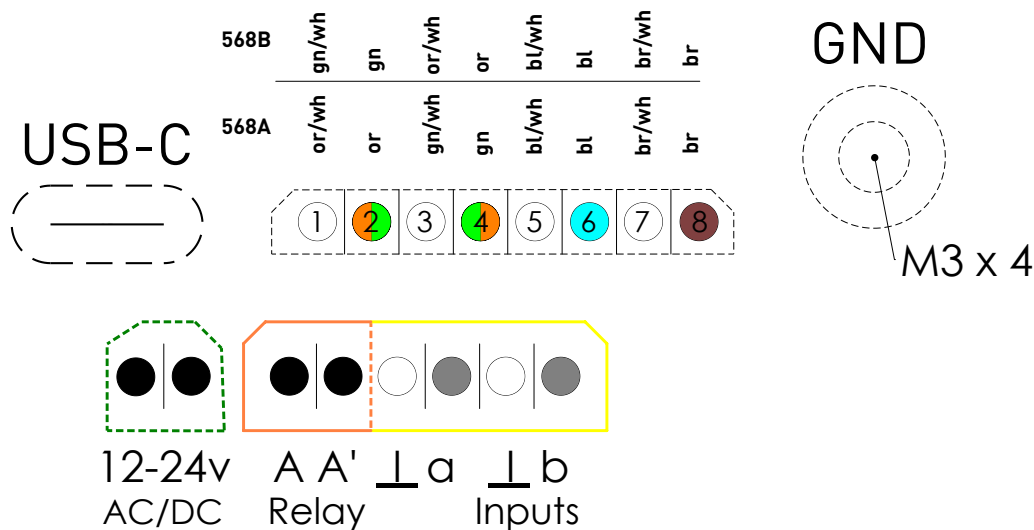

- Power Options:
 - Power over Ethernet (PoE 802.3af, Class 3) via 8-Pin Connector (PTSM 0.5/8-P-2.5)
 - 12V-24V DC external power supply via 2-Pin Connector (PTSM 0.5/2-P-2.5)
 - 24V AC power source via 2-Pin Connector (PTSM 0.5/2-P-2.5)
 - Standby consumption is approximately 5W.
- Network Options:
 - Gigabit Ethernet for wired connectivity
 - Dual-band Wi-Fi (2.4 GHz and 5 GHz, 802.11 b/g/n)

- Bluetooth Mesh for local frogblue device communication, automation & access
- Onboard Inputs & Output:
 - Inputs: 2 x Potential-free contacts (self-supply 2 V / max. 1mA)
Low voltage contacts (max. 30W / 50VDC)
 - Relay Output: 1 x potential-free relay output (max load: 30 W / 50 VDC.)
- Additional Connections:
 - M3 x 5 Grounding Screw Connector: Ensures proper earth connection and shielding for the PoE cable.
 - USB-C Port: Reserved for future expansions or accessories.
- Connection Tips:
 - Tighten screws securely on input/output connectors to ensure a stable connection.
 - Ensure the ground screw is connected for safety and shielding.
 - A small dab of non-permanent silicone adhesive can be applied to the sides of the phoenix connectors to keep them in place. Use a type that is easily removable for maintenance, such as neutral cure silicone, which won't damage the housing or connectors.
 - For PoE setups, use a compatible network switch or injector that meets the 802.3af / class 3 standard.

2.3 Dimensions & Weight

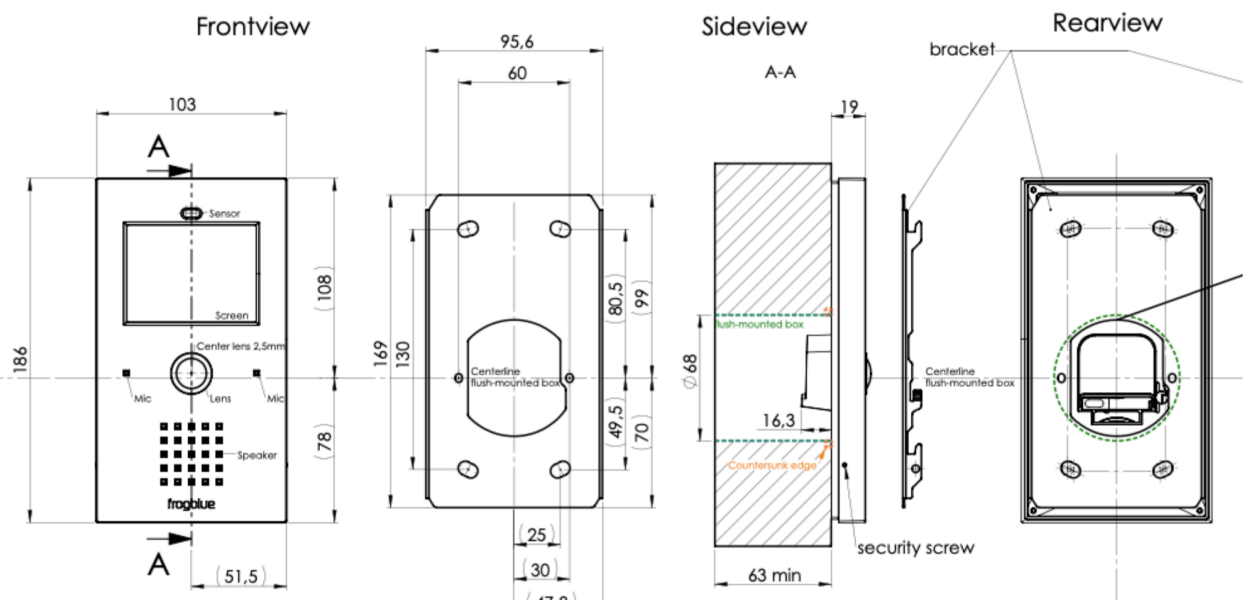

- **Dimensions:** (L x W x H): 186 x 103 x 35.3 mm
- **Weight:** 360g
- **Back Box Dimensions:** Standard \varnothing 68 mm diameter for socket and switch installations (DIN 49073-1 / EN 60670-1). **Minimum depth:** 53 mm for installation in the back-box module. **Recommended depth:** 63 mm for optimal installation of the back-box module.

2.4 Installation Site Assessment

Prior to installation, perform a site assessment to confirm:

- The optimal mounting height for ease of operation.
- The best network connection method (wired vs wireless).
- Sufficient clearance for device access and maintenance.
- Compliance with safety regulations and building codes.
- Telephony Assessment:
 - **Multi-tenant setup:** Verify communication options (SIP, DECT, or PSTN phone systems).
 - **Smartphone compatibility:** Confirm availability of smartphones running frogSIP Apps.
 - **Cloud/Internet connectivity:** Ensure remote telephony capabilities if required.

2.5 Required Components for Installation

Ensure all required components are available before installation:

- frogTerminal with up-to-date firmware or frogOS file ready before deployment see frogblue.com → Support → Software.
- Mounting bracket and screws (included in the box).
- Power source (PoE injector, DC power adapter, or AC power connection).
- Network cable (Cat 5e or higher for Ethernet setups).
- RFID cards or key fobs (if access control functionality is required).

2.6 What's in the Box

For the models: **frogStation KL, frogTerminal KL, frogTerminal Glas, and frogTerminalALU**. The following items are included in the box:

- Package insert sticker with serial, barcode, version information.
- frogTerminal, Aluminium mounting plate with attached gasket seal.
- 4 × screws (Ø4.5 × 40 mm).
- 4 x Insulation fixings - plastic spiral dowels or "anchor plugs".
- 4 × dowels or "anchor plugs" (UX6).
- 1.5 mm hex key (for locking side screws).
- 2-pin, 6-pin, and 8-pin Phoenix plug connectors (for power, I/Os, and Ethernet).
- 1 x RFID frogblue Card
- Package leaflet with operating instructions.

3. Physical Installation Process

3.1 Mounting the Device

Steps:

- Mount the terminal.
- Connect power (PoE or external).
- Wire inputs/outputs for relays or buttons.

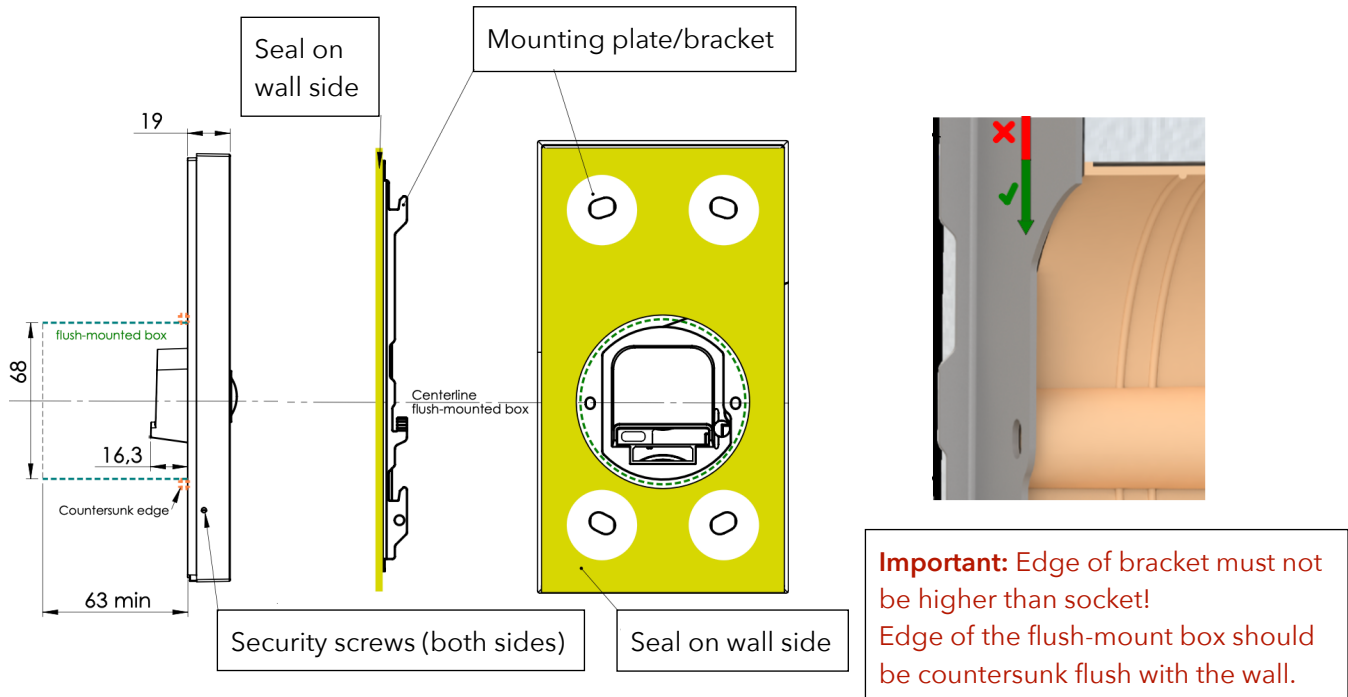

3.1.1 Standard Surface-Mounted Installation

Standard steps for an on wall surface-mounted installation with the following frogTerminal models: **frogStation KL**, **frogTerminal KL**, **frogTerminal Glas**, and **frogTerminalALU**.

- Prepare a recess with a minimum depth of 53 mm (recommended 63 mm) and a Flush-mounted junction box.
- Screw the mounting plate/bracket onto the flush-mounted box using the 2 screws.
- Align the plate and mark the 4 screw holes (use the holes as a template).
- Remove the mounting plate/bracket and drill the 4 holes.
- Insert the dowels or "anchor plugs" (UX6). If fixing to insulation e.g. Styrofoam, use the included insulation Anchors (larger spiral type dowels).
- Fix and align the mounting plate/bracket using the 2 device screws (included in the box).
- Secure the mounting plate/bracket by screwing in the 4 included screws (Ø4.5x40) into the previously installed plugs (UX6).
- Connect the cables to the Terminal KL (PoE cable, Ground screw, Power, Inputs & Output).
- Ensure proper grounding (use the extra screw in the back panel).
- Place the Terminal KL onto the mounting plate/bracket and slide it down until it clicks into place.

- On the left and right sides of the door station, use the hex screwdriver to tighten the set screws, securing the door station against theft. Turn the screws anti-clockwise to activate the theft protection and clockwise to release it.

3.1.2 Flush-Mounted Installation

- Prepare the recess in the wall following the specified dimensions.
- Insert the flush-mount box and secure it with screws.
- Mount the frogTerminal into the box and align it properly.

3.2 Connecting Power & Network

- If using power over Ethernet (PoE), connect the Ethernet cable to a PoE switch or injector that complies with 802.3af / Class 3, and to the Terminal with the 8-Pin Phoenix connector.
- If using a 12-24V DC or 24V AC power adapter, connect the leads with the 2-pin Phoenix connector to the Terminal.
- Verify the Terminal boots up into the Start Wizard screen or a preconfigured user interface indicating proper operation.
- Connection Tips:
 - Tighten screws securely on the Phoenix connectors.
 - A small dab of non-permanent silicone adhesive (neutral cure silicone) may be applied to stabilise the connectors.

4. Initial Setup & Configuration

On-Device Touch Screen Installation Wizard

The on-device wizard simplifies the initial configuration of the frogTerminal, walking you through the essential settings step by step. This section ensures a smooth installation experience, even for users with minimal technical expertise.

The wizard can be accessed again at any time with a factory reset. Currently in development, sections of the wizard will be directly accessible—allowing you to repeat specific steps, such as cloud registration, smartphone pairing, or other key configurations.

Steps Overview:

- Configure localisation settings: language, date, and time.
- Secure the interface setting an Admin PIN for configuration via the touch-screen interface and a Web Password for remote administration via a browser.
- Set up network settings & frogBlue Mesh.
- Register the terminal with SIP/cloud services.
- Configure call bell settings.
- Complete the setup and test the device.

To start the Installation Wizard: Power on the device & tap “Start Wizard”.

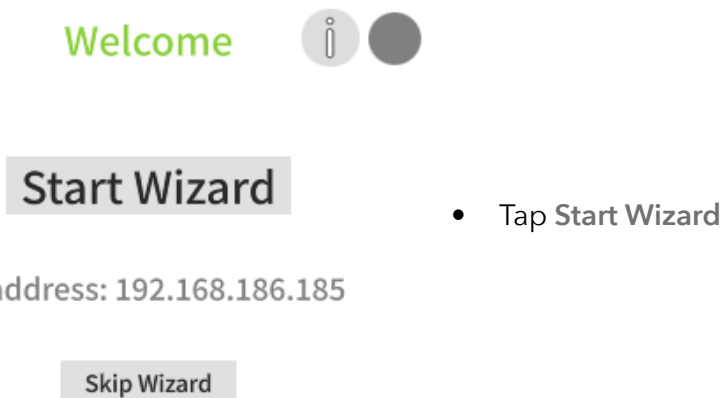

4.1 Installation Wizard Step 1: Set Language and Timezone.

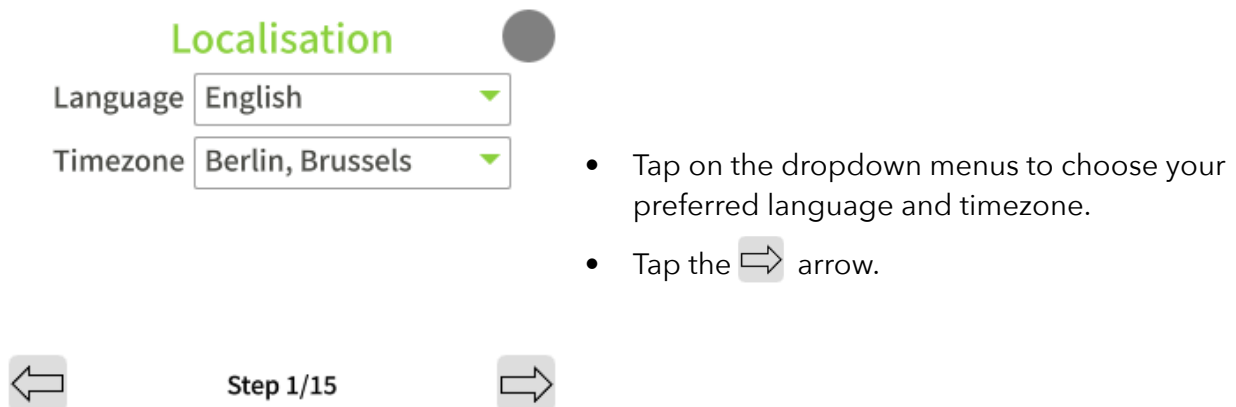

4.2 Installation Wizard Step 2: Define the Admin PIN.

Admin PIN



Please define twice the admin PIN



- Tap the first key icon.



Step 2/15

1	2	3
4	5	6
7	8	9
C	0	OK

- Enter your chosen 6 Digit Admin PIN number using the on-screen keypad and tap "OK".

Admin PIN



Please define twice the admin PIN



- Tap the second key icon.



Step 2/15

1	2	3
4	5	6
7	8	9
C	0	OK

- Enter your 6 Digit Admin PIN number once more and tap "OK".

Admin PIN



Please define twice the admin PIN



- Tap the next arrow  .



Step 2/15



4.3 Installation Wizard Step 3: Set the Web Password / HTTPS Admin Password.

Web Password



Password: Password

- Tap on the light-grey **Password** text input field (right side).



Step 3/15

Web Password



Password: Password



- Using the on-screen keyboard enter your chosen password for the **admin** user.

Note: Passwords must be at least 8 characters long and include at least one uppercase letter, one lowercase letter, and one number.

Web Password

Password: ●●●●●●●●●●

Use "admin" as username

- Tap the next arrow .

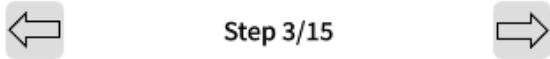

Note: Make a note of or record your specified web password, as it will be required later to administer the Terminal through a web browser.

The factory default login credentials for accessing the camera via web browser are:

- Username: admin
- Password: frogblue

4.4 Installation Wizard Step 4: frogBlue Mesh Setup.

frogBlue Mesh

Lock the BT interface 

Secure the Bluetooth interface.
The device will not be integrated with a frogblue Bluetooth Mesh at this stage.

- Tap the drop-down arrow ( top right).

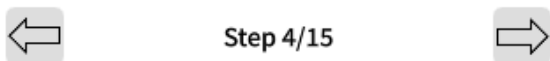

frogBlue Mesh

No change (open) 

Lock the BT interface

Set Project Key

No change (open)

- Tap your desired option.
- Either tap the next arrow, or enter the Project Key and tap the next arrow .

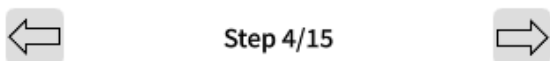

Lock the BT Interface: The frogblue Mesh is locked and needs to be unlocked by performing a factory reset see section 20.2 „System Control - Manage configuration files, Reboot, and Factory Reset“.

Set Project Key: The frogblue Mesh is encrypted and you set the Project Key in the next step - frogBlue Mesh functionality is ready to use and the frogTerminal can be integrated into a project with this specified Project Key.

No change (open): The frogblue Bluetooth Mesh remains open and unencrypted. Anyone with the frogProject App or configuration tools can commission the system via Bluetooth.

Warning!: When selecting "No change (open)", the system **remains insecure until** the configuration has been completed and the Terminal has been **commissioned** (e.g., with the **frogProject App**).

4.5 Installation Wizard Step 5: Set Device Name.





- Tap the text area "Main Door" and use the on-screen keyboard to enter a name for your Terminal.
- Tap the next arrow .

4.6 Installation Wizard Step 6: Set the Home Screen Layout

Define the Home Screen Layout, the default view displayed when the Terminal is on standby and ready to be activated by touch, proximity, motion, input, etc.

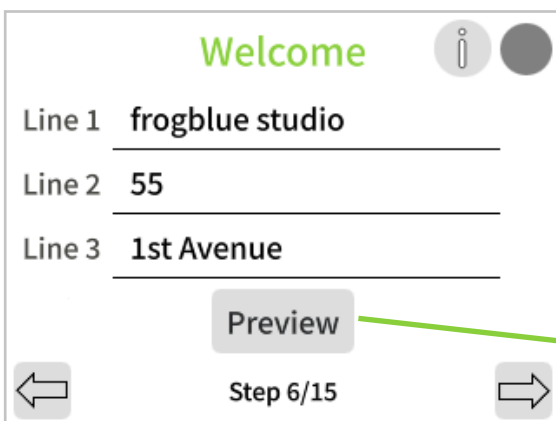
Note: Currently in development with a software update currently under development, the Home Screen will feature customisation options for images, logos, styles, search functionality, and scrollable call lists.





- The Home Screen defines the standby view.
- Tap to set your text for each of the lines.
- Tap "Preview" to view your setup.
- Tap the next arrow  to proceed.





4.7 Installation Wizard Step 7: Connect frogTerminal to your physical or Wi-Fi Network.



- Tap on the icons  &  to configure the Ethernet and Wireless Interface Settings.

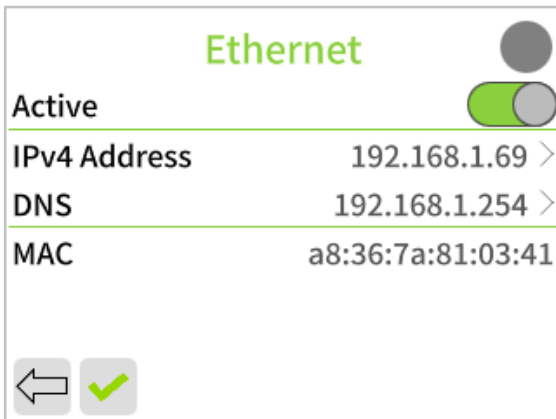

Ethernet Configuration:

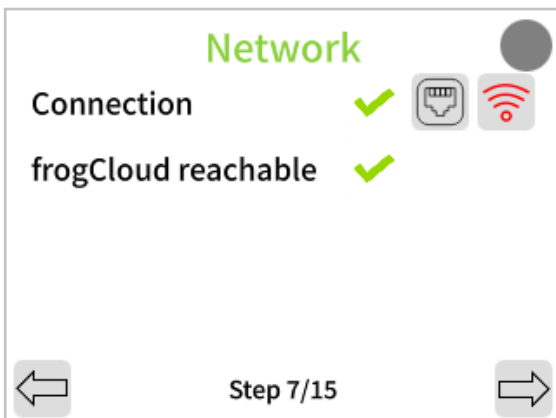

- Leave Active or deactivate Ethernet via the toggle switch if using Wi-Fi.
- Tap the lines to modify IPv4 address or DNS Settings.
- Tap  to return, or  to save changes and return to the Network Setup Page.

Wi-Fi Configuration:



- Ensure 2 green ticks  for Connection and frogCloud.
- Tap Next  to continue.

Note: If you experience connectivity problems see section 5.1.5 Troubleshooting Network Connectivity Problems.

4.8 Installation Wizard Step 8: Connect to frogCloud

For quick and easy connectivity with a smart device, a frogCloud account is recommended.

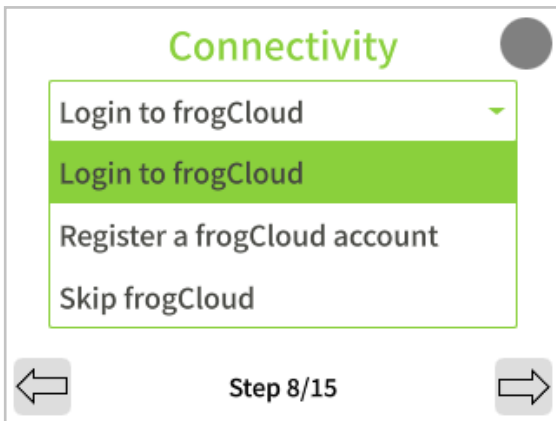



- To add to an existing or to create a frogCloud project for this installation, tap 'Login to frogCloud'.
- To register a new frogCloud account and create a new frogCloud project for this installation, tap 'Register a frogCloud account'.
- To proceed with a custom or advanced setup without the free frogCloud service, tap 'Skip frogCloud' and proceed to Section 4.1.16.

Note: A confirmed email is required for frogCloud. Create and manage accounts via the frogSIP App (iOS/Android) or at frogblue.cloud/login.

4.9 Installation Wizard Step 9: Login to or register for a frogCloud Account

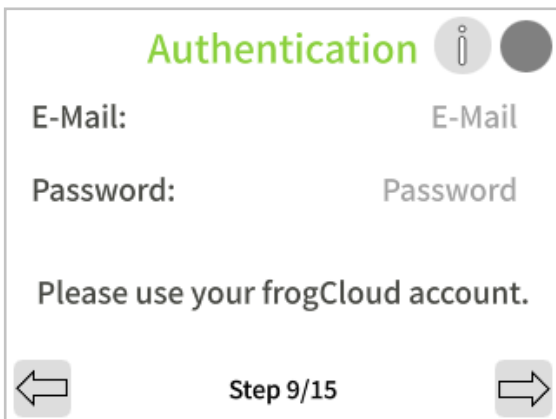
Login to an existing frogCloud Account:



- Tap on the text areas 'E-Mail' and 'Password'.
- Use the on-screen keyboard to enter your existing frogCloud account credentials.
- Tap Next  to continue.

Register for a new frogCloud Account:

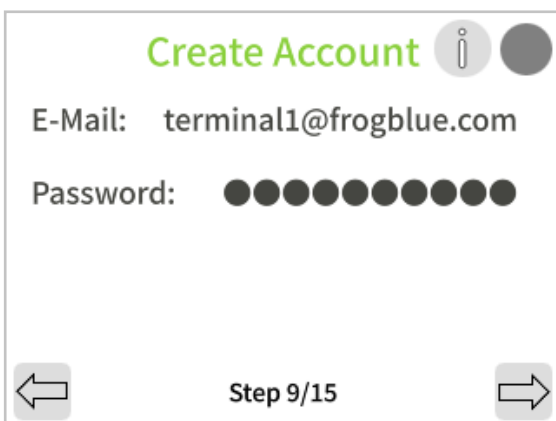

- Tap on the text areas 'E-Mail' and 'Password'.
- Use the on-screen keyboard to enter your email address and a password of your choice for your frogCloud account.
- Tap Next  to continue.

4.10 Installation Wizard Step 10: Confirm account activation E-Mail

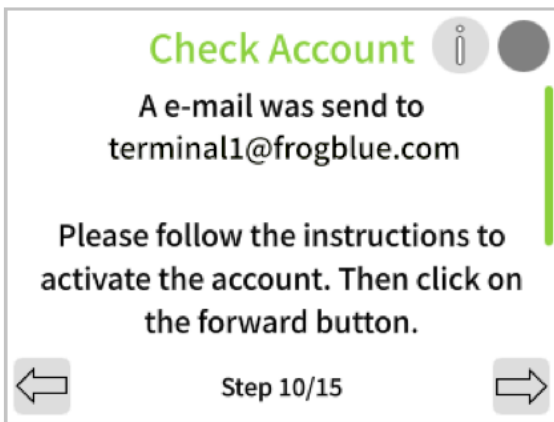

Open your email inbox, click the provided confirmation link, and log in with your email and password to activate your frogCloud account with SIP call functionality.

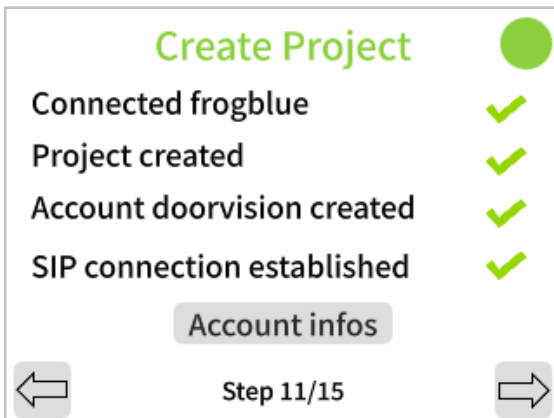

- Wait for the following message confirming that an E-Mail has been sent to your address.
- Check your E-Mail, click the link, then login with your username and password to activate your new frogCloud account.
- Tap Next  to continue.

4.11 Installation Wizard Step 11: Create Cloud Project



- Wait for the and ensure green ticks  for each item indicating a successful connection to frogCloud, project creation, Terminal SIP account creation, and successful SIP telephony connection.
- Tap account infos to see advanced SIP account details.
- Tap Next  to continue.

4.12 Installation Wizard Step 12: Create Bell Buttons



- Tap 'Tom Smith' and use the on-screen keyboard to enter a name label for your first Bell Button.
- Tap Next  to continue.

4.13 Installation Wizard Step 13: Pair with smart device







- Use your smart device with the frogSIP App to enter the Invitation Code or scan the QR Code to pair with your Terminal.
- Once paired you can initiate a test call by tapping the **'Test Call'** button
- When finished, tap Next  to proceed.

4.14 Start View and View Modes Explained

The Start View appears when the Terminal is activated via proximity detection or touch. Views are made up by a main area and a toolbar. The system supports 4 view modes with further customisation of the toolbar possible via the Web Browser.

Toolbar buttons:

-  Enables the entry of Function PINs.
-  Opens the Camera dialog. Refer to section 8 „Camera Settings and Recording Management“ for details on configuring in-stream settings.
-  Opens the on-device touch screen configuration and administration pages.
-  Enables calling by Apartments or Unit numbers. NOTE! Works only when numbers have been defined for each call entry in the **Apartment** field in **Settings** → **Call destinations**.

View Mode 1. Bell Buttons:

This view provides Bell Buttons in the main area and 3 Toolbar Buttons.



View Mode 2. App + Pins:

This view provides PIN code and apartment / unit number entry in the main area and 4 Toolbar Buttons.

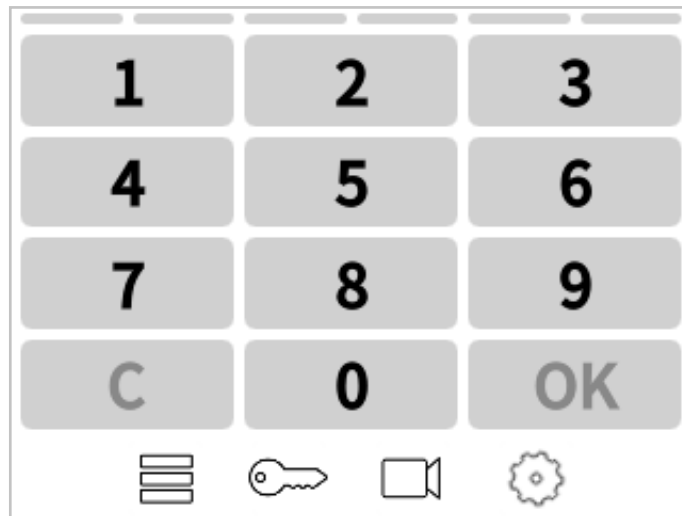

View Mode 3. PINs:

This view provides PIN code entry in the main area and 3 Toolbar Buttons.

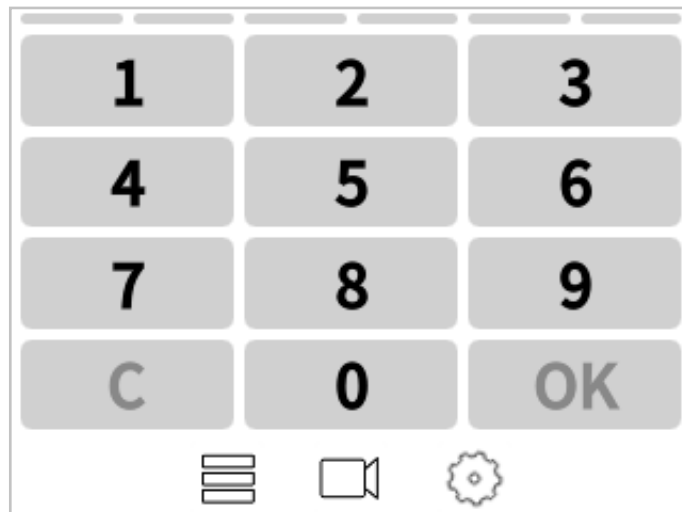

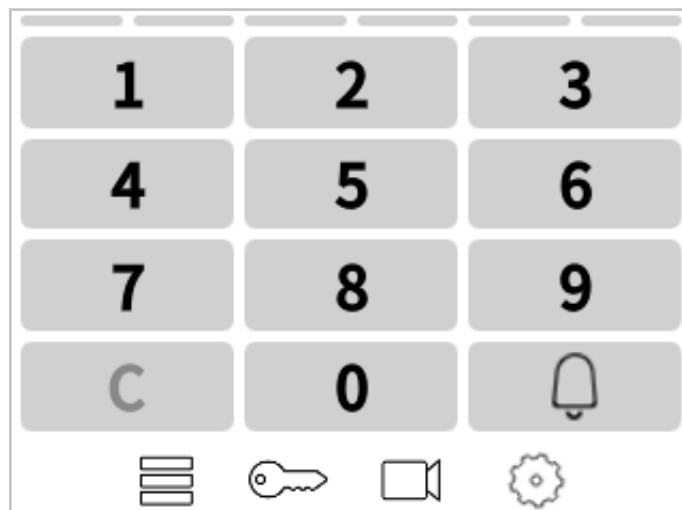

View Mode 4. Apartment:

This view provides apartment / unit number entry in the main area and 4 Toolbar Buttons.

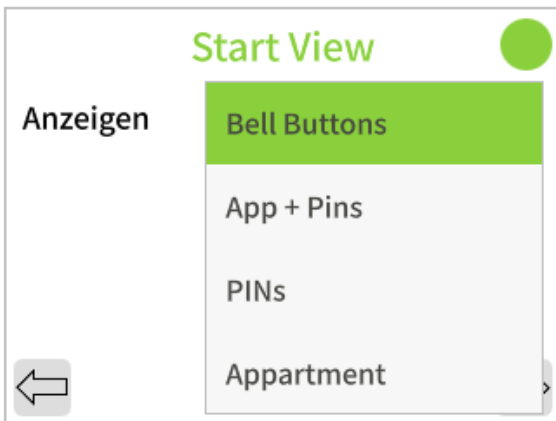

4.15 Installation Wizard Step 14: Start View



- Select your desired Start View.
- Tap Next  to continue.



4.16 Installation Wizard Step 15: Finalise Wizard.

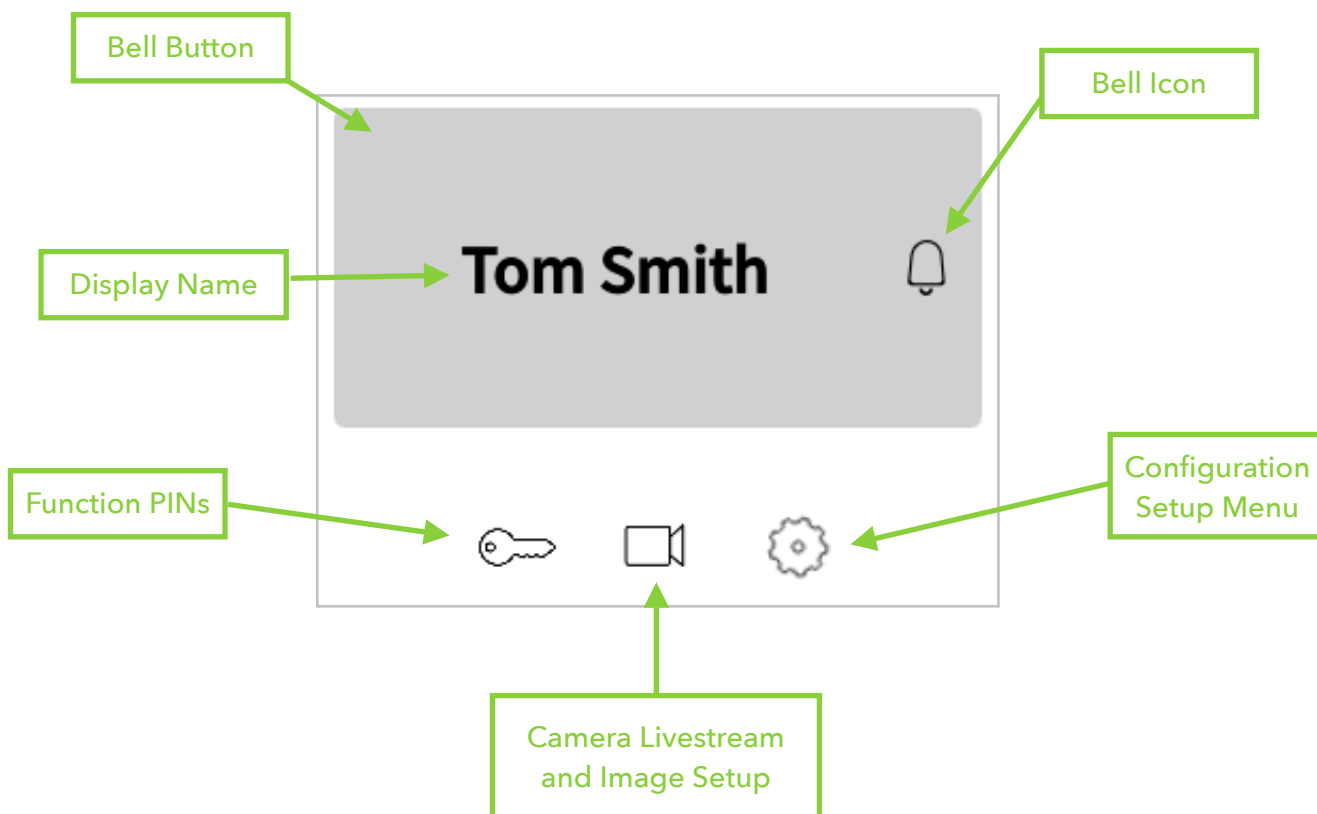

- You're all set! The welcome screen appears, confirming the Wizard's completion.
- Tap Next  to proceed.

Wizard Complete!



Congratulations on completing the frogTerminal Installation Wizard! You can now make calls using the Bell Button (e.g., "Tom Smith"), trigger Function PINs  and access the on-screen camera  and system setup pages  using your Admin PIN.

5. frogSIP App User Interface

5.1. Introduction to frogSIP

The **frogSIP** app serves as the **primary interface** for managing and interacting with **frogTerminal** devices. This section provides a step-by-step guide on **pairing** the app with **frogTerminal**, configuring user **settings**, managing **security logs**, and reviewing **call history**.

5.2. Welcome Screen Overview

Upon launching the frogSIP app, users are presented with the **Welcome Screen**. The interface will automatically match the language of the smartphone device. To change the language tap the **Burger Menu** → **Settings** → **General** → **Language** and select your desired language.

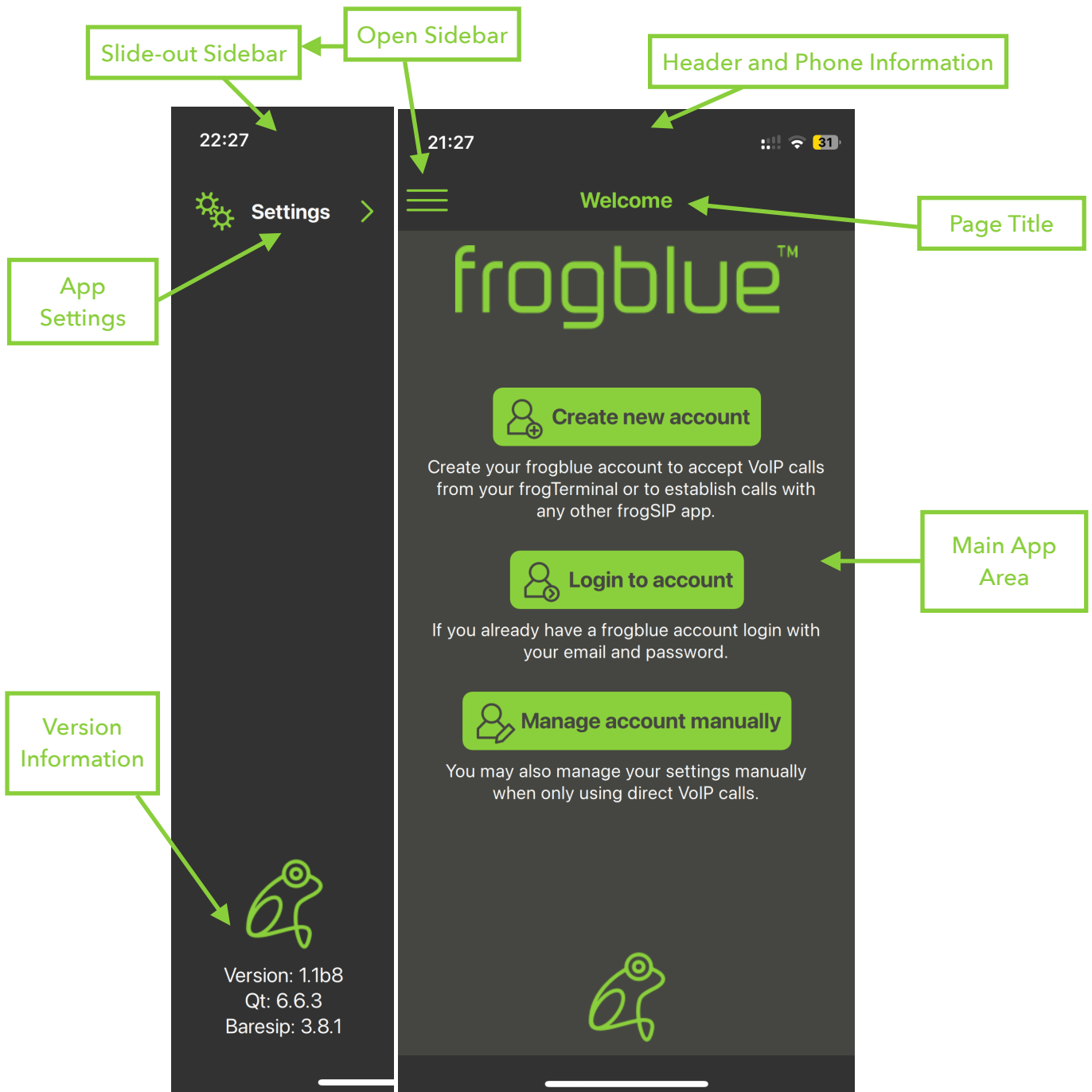

Note: To begin we will cover creating and logging into fogCloud accounts. **Manage account manually** is used for custom SIP integrations and covered in a later section.

5.3. Create a new frogCloud user account from the frogSIP App

This section guides you in creating a frogCloud account from the frogSIP app Welcome Screen.

If you've skipped the welcome screen and wish to return simply tap the **Burger Menu** → **Account** → **Logout**, then tap **Logout** again to confirm.

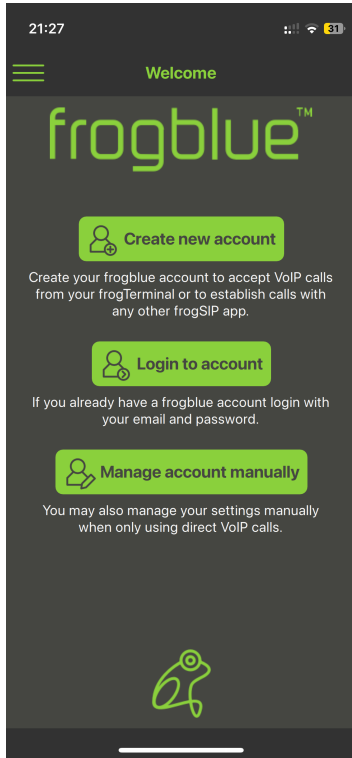

- Tap **Create new account**

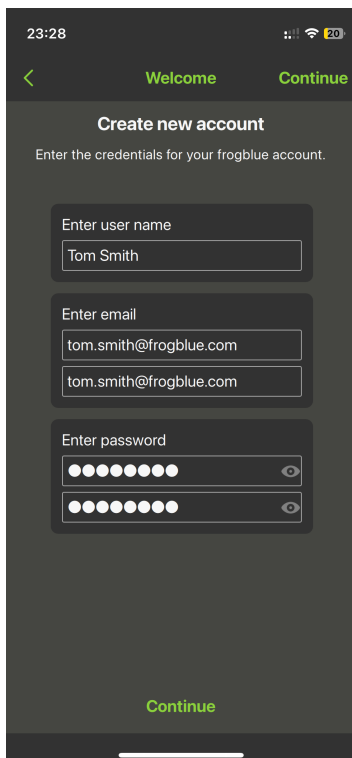

Enter your information:

- **User name:** The user and display name for this frogCloud user account.
- **Email:** Enter and repeat the email address associated with this frogCloud user account.
- **Password:** Enter and repeat the password for this frogCloud user account.
- Tap **Continue**

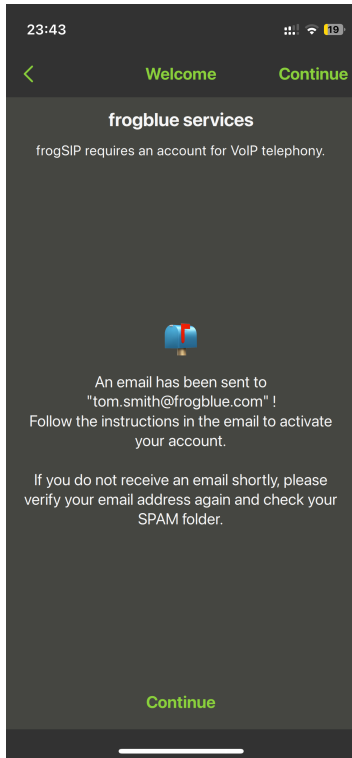

- Wait for the following message confirming that an E-Mail has been sent to your address.
- **Check your E-Mail** and click the link to open the frogCloud login screen in your web browser.
- **Login** with your username and password to **activate your new frogCloud account.**
- Tap **Continue**

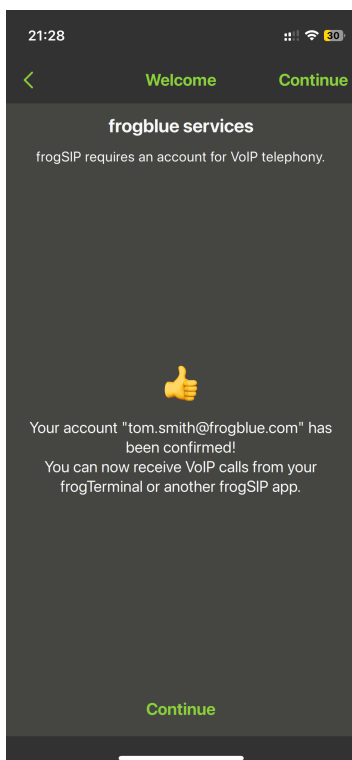

- Wait for the following message confirming that your new account is **activated.**
- Tap **Continue**

If you receive any error ensure the following:

1. Your **frogTerminal** is **updated** to the **latest frogOS** version, available from frogblue.com.
2. Your **frogSIP App** is also updated to the **latest version.**

5.4. Login to the frogSIP App with an existing frogCloud user account

If you're logged in and want to log out, tap the **Burger Menu** → **Account** → **Logout**, then tap **Logout** again to confirm.

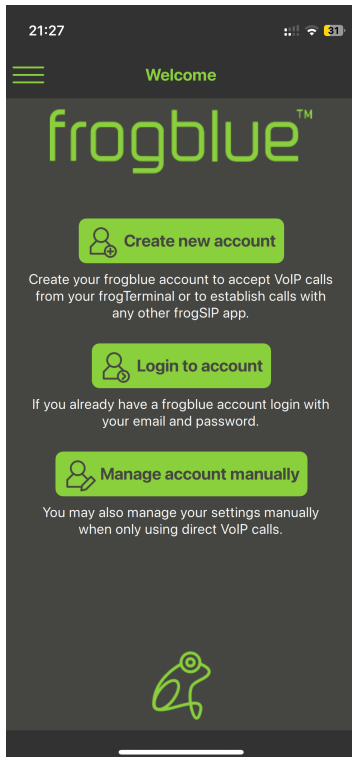

- Tap **Login to account**

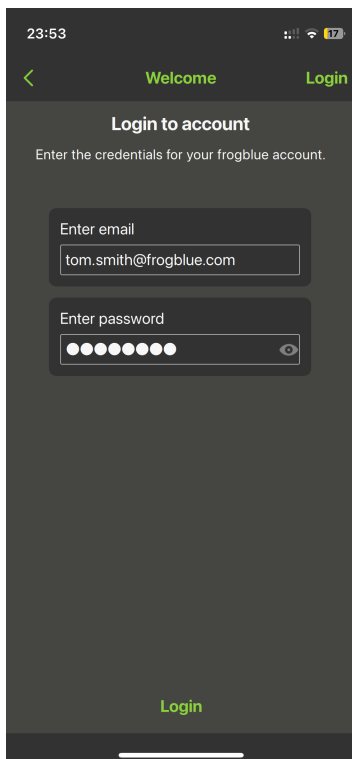

Enter your information:

- **Email:** Enter the email address associated with your frogCloud user account.
- **Password:** Enter the password for your frogCloud user account.
- Tap **Login**

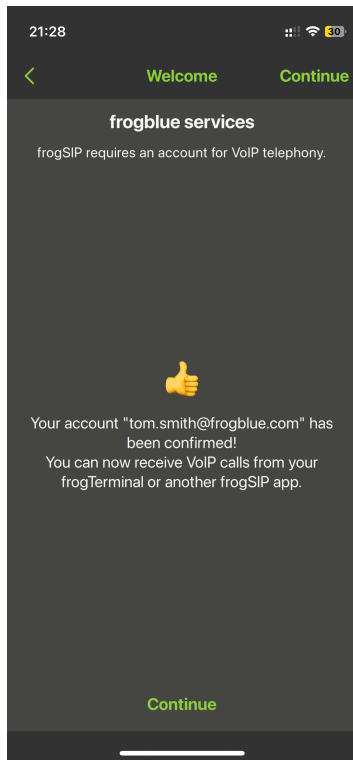

- Wait for the following message confirming that your account is **activate**.
- Tap **Continue**

5.5. Main App Interface Overview



The **frogSIP App** provides a streamlined interface for managing SIP-based video intercom and access control systems. The user interface is designed for efficiency, with a **slide-out sidebar** for quick access to key functions.

- Touch-Friendly Design for mobile and tablet usage.
- Dark & Light Mode Support for better visibility in different environments.
- Multi-Language Support for international deployments.
- Real-Time Notifications for call alerts, access logs, and system events.

The main view consists of the following sections:



Details:

- **Open Sidebar (Burger Menu):** Toggles the slide out sidebar, to provide quick access to account, app, and door terminal settings.
- **Slide-out Sidebar:**
 - **Account Settings:** Manage your frogCloud account.
 - **App Settings:** Manage user & password settings, logout, or delete your account.
 - **Door Terminals:** View a list of Terminals paired with the App.
 - **Version Information:** Access details about the versions of the App and its bundles.
- **Phone Call Directory:** Quickly call any paired users or devices from a call directory.
- **Header and Phone Information:** Displays standard iOS/Android device details.
- **User Name:** The username associated with your frogCloud or SIP account.
- **frogCloud connection Status:**  Undefined  No connection  Connected
The connection status indicator displays the link between the App and frogCloud. A green light means the connection is active, red indicates that there is no connection, and grey signifies that the App is not properly configured.
- **Add remote Station or User:** Quickly add or pair with a new remote station or user.
- **frogCloud ID / SIP username:** Your frogCloud ID or SIP authorisation username.
- **Favourites / Call shortcuts:** Quick-access buttons for calling your favourite
- **Main View:** The smartphone camera is blurred by default when not in a call. To disable the blur, go to Burger Menu → Settings → Appearance and toggle “Blur camera self-view.”
- **Toolbar:** Active During Calls with a frogTerminal. Access controls for enabling/disabling video and microphone, and quickly view recordings, logs, lights, and door controls.

5.5.1. In-Call Toolbar



- **Logs & Playback:** Review access & bell logs, and video playback of recordings.
- **Speaker-mode:** Toggle speaker-mode for hands-free communication during calls.
- **Audio/Video:** Enable or disable the sending of audio and video from your device to the Terminal.
- **Lights:** Control the Terminals “Light” HomeObject.
- **Doors & Openers:** Control the Terminals door openers.

5.5.2. Logs & Playback Toolbar

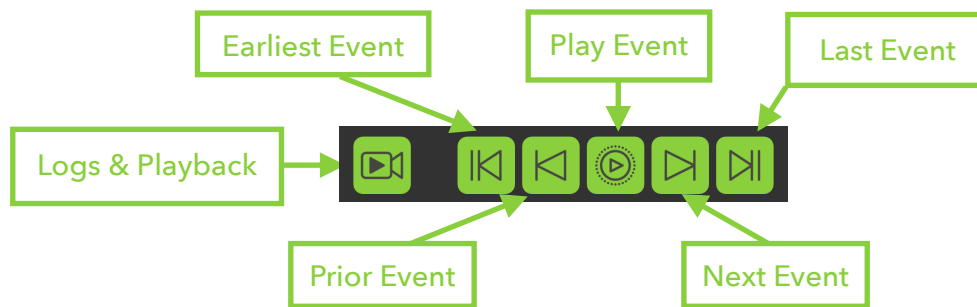

- **Logs & Playback:** Toggles between the research player view—used for video recording playback and reviewing access or event logs—and the live call view.
- **Earliest Event:** Jump to the earliest recorded event in the system.
- **Play Event:** Plays back the recording sequence if more than one frame has been recorded for this event.
- **Last Event:** Jump to the last recorded event in the system.
- **Next Event:** Jump to the next recorded event in the system.
- **Prior Event:** Jump to the previous recorded event in the system.

5.6. Pairing the Terminal with frogSIP App

In this section, you'll learn how to pair your terminal with the frogSIP app on your smartphone. You can complete the pairing process either by entering a pairing PIN code or by scanning a QR code via frogCloud. This secure connection ensures seamless integration, enabling you to efficiently manage calls and configure settings from your mobile device.

frogCloud makes pairing and connecting multiple sites and door Terminals a breeze.



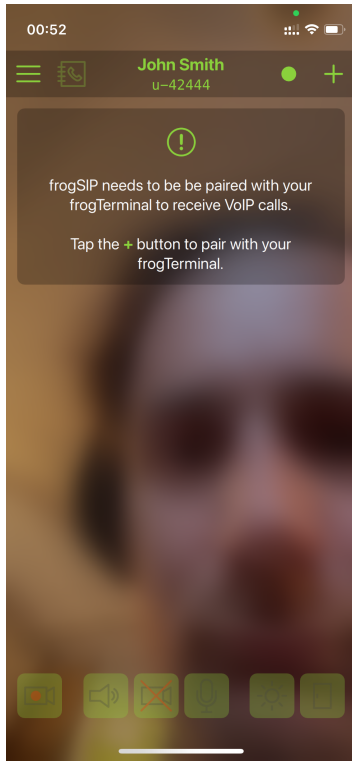

- Tap the + Icon **Add remote Station** on the top right.

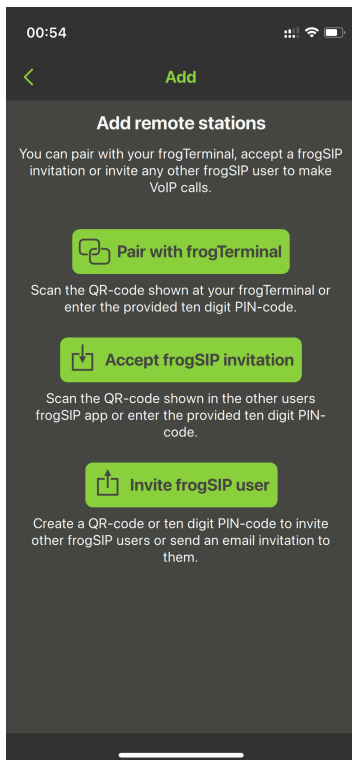

frogSIP can be linked with frogTerminals as well as with other frogSIP users for calling functionality.

Use Invite frogSIP user to connect with another App user and Accept frogSIP invitation to accept an invitation.

Users can connect either with a simple QR code or via an invitation PIN number.

- Tap **Pair with frogTerminal** to proceed with connecting to your frogTerminal.

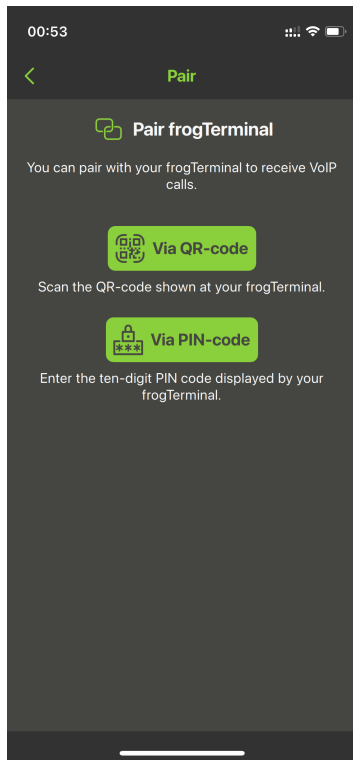

The Terminal can be paired in 2 convenient ways:

- **Via QR-code:** Ideal for quick and easy pairing when the smartphone running frogSIP is in the same location as the Terminal during the Wizard setup.
- **Via PIN-code:** Perfect when the smartphone is at a different location. Simply send the Invitation Code to the person with the smartphone to complete the pairing process remotely.

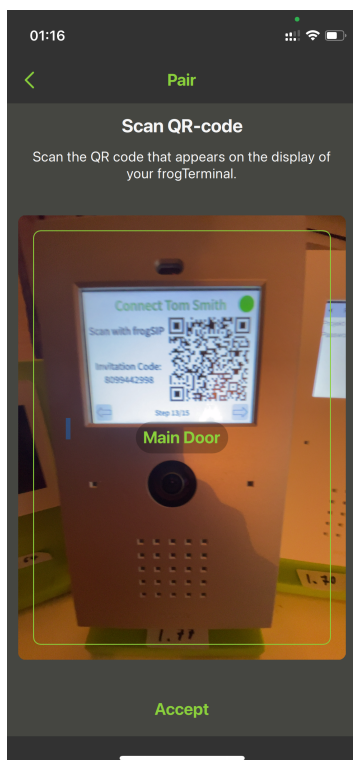

Use your smartphone camera to scan the QR code displayed on the frogTerminal device screen.

Tips:

- Once the device name appears on the screen and the **Accept** button turns solid green, the QR code has been successfully recognised. You can stop keeping the QR code in the camera frame and simply press the **Accept** button.
- If you're having trouble scanning the QR code, you might be holding your phone too close or too far away. Adjust the distance by moving your phone closer or farther away. The ideal distance is typically when the entire frogTerminal screen fits within your camera frame.
- If you are pairing with an invitation PIN code, simply enter the code and tap **Continue**.

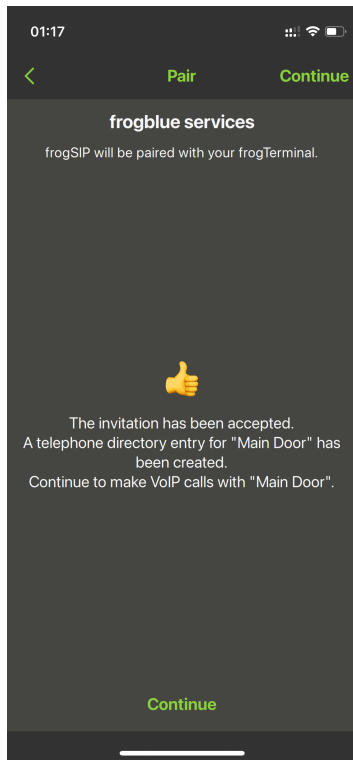

When you see the message “The invitation has been accepted ...”, your Terminal and frogSIP App have been successfully paired. You can now tap **Continue**.

If you receive an error, such as “The invitation code is not valid for this version! ...”, ensure the following:

1. Your **frogTerminal** is **updated** to the latest frogOS version, available from frogblue.com.
2. Your **frogSIP App** is also **updated** to the latest version.

5.7. Call, Playback, and Manage frogTerminal with frogSIP

This section details how to use frogSIP with your frogTerminal. It covers initiating calls, accessing and reviewing recordings, and managing device settings.

5.7.1. Receiving calls

Receiving calls is as simple as answering a phone call. After pairing with the Wizard, calls to your smartphone work automatically. For further configuration, see section 7 „Telephony Call Destinations Setup“. Calls can be received with frogSIP or from a frogStation, frogDisplay, SIP Phone, or of course another frogTerminal.

Once call is connected, the interface is identical to that of initiated calls—the following sections detail the interface for both initiated and received calls.

5.7.2. Auto Answer Configuration

For the frogTerminal to automatically answer calls from authorised users, ensure **Max auto answer level for users** is set to **Automatic answering** from **Web → Settings → General**.

Additionally, users can be restricted to audio-only or full audio/video access via **Web → Call Destinations → Bell signs**.



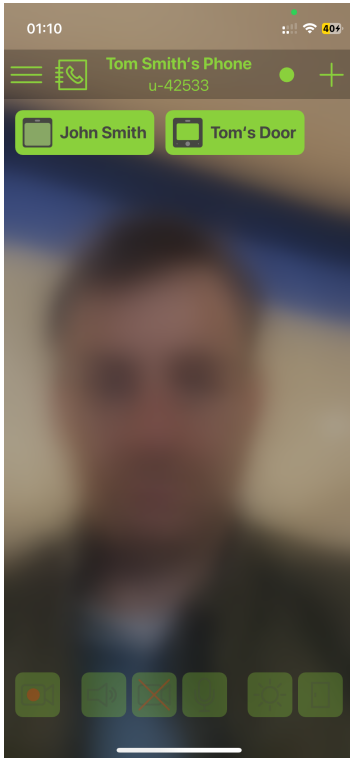



5.7.3. Initiate calls

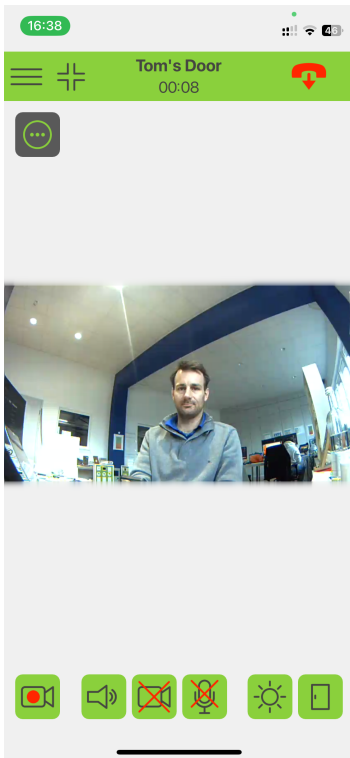

- Tap the **Call Directory** or select from your **Favourites** to initiate a call with your frogTerminal.

Once a call is connected, the toolbar appears. To enable the video toggle before the call connects, go to **Burger Menu** → **Settings** → **Video** and turn on **Allow early video**. This setting lets you activate your video feed before making a call.



-  Hide the toolbar to provide more space for the video call.
-  Trigger a manual recording from within the call.
-  Hangup the call.
-  Open the quick menu to take a picture or trigger recording from a call.
-  Toggle on/off the light.
-  Open the door - when multiple doors are configured another dialog appears allowing you too see the door states and choose which door to open.

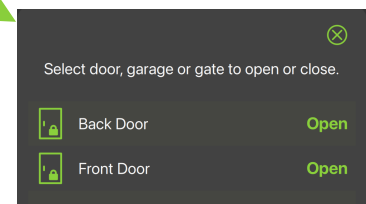

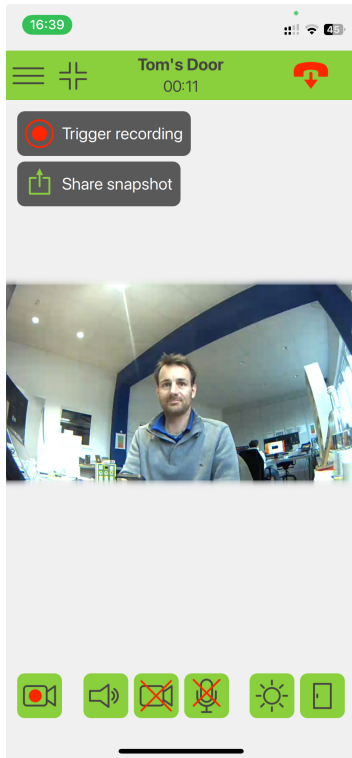

To take a picture or trigger recording from a call tap  to see the following options.

- **Trigger recording:** Triggers a recording via the user click event in the frogTerminal. Manually starts the recording of 1 event. Goto **Settings** → **Recording** to check and modify recording settings.
- **Share snapshot:** Take a current still image from the Terminal and share it via your smartphone sharing options.

5.7.4. Access & Event Logs and Playback from a frogSIP call

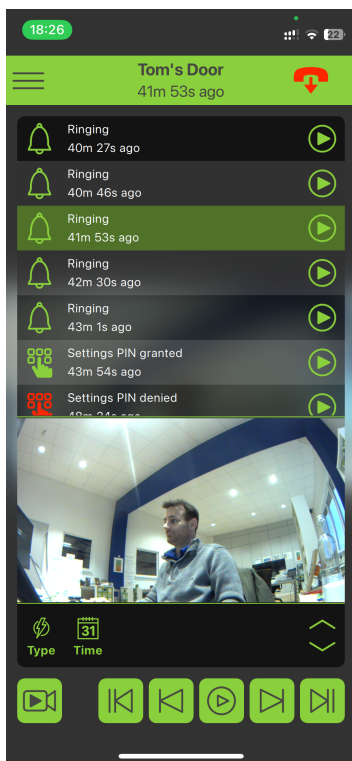

Tap the **Logs and Playback** button (Bottom left).

- Filter events by type or date range using the lower toolbar.
- Tap an event to play back its associated video recording in the same view, and use the player toolbar controls to manage playback.
- Tap the player icon to open the full-screen player, which features a larger video display and additional options in its top toolbar.

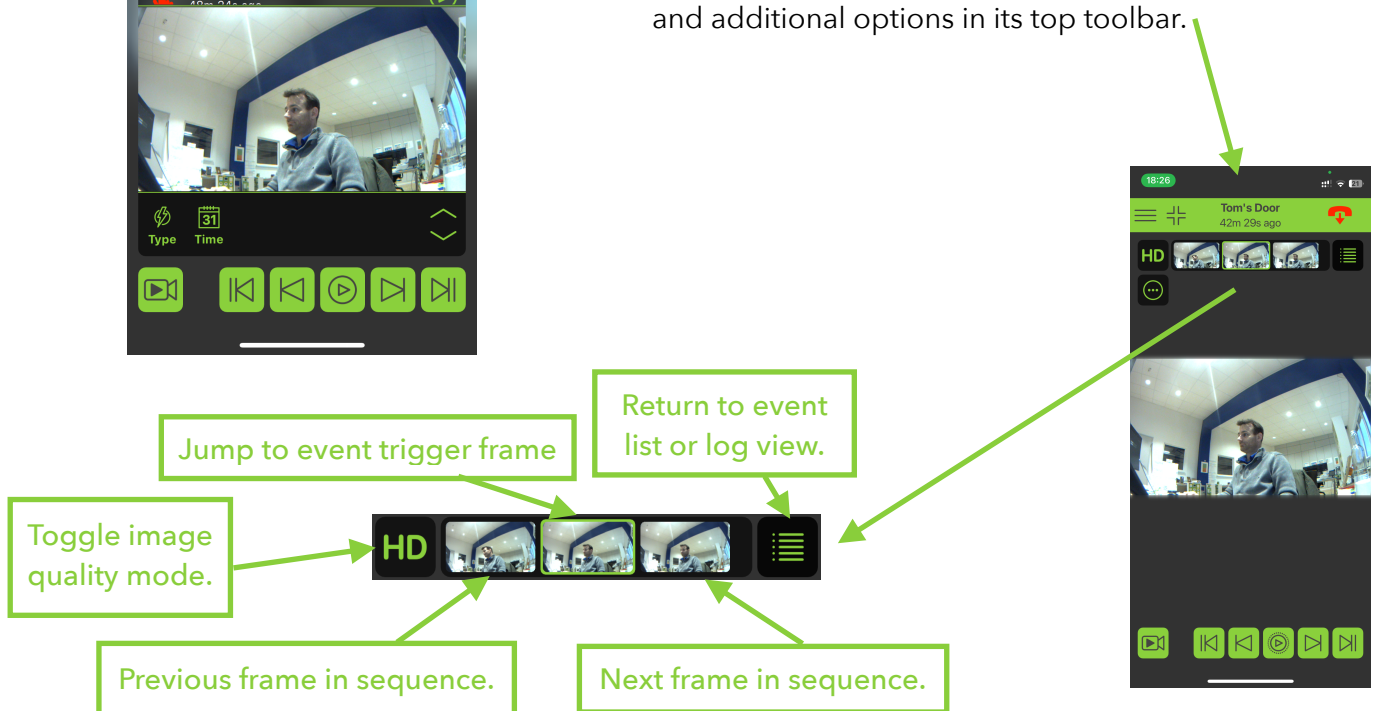

6. Access Control Configuration

6.1. Introduction to frogTerminal Access Control

The frogTerminal offers efficient and flexible time-based access control using PINs, RFID cards, and even phone calls, without requiring a constant cloud or network connection. The system is designed to simplify access management while maintaining robust security.

For RFID cards, the frogTerminal employs the international standard DESFire EV2, ensuring reliability and security. Cards or key fobs can be written at any frogTerminal and then used across all terminals within the same project—no additional configuration is needed. While a network connection is optional, it enhances convenience by enabling remote administration via the network or internet.

6.2. PINs, Access Codes

There are a number of Numerical Codes for Operating the frogTerminal.

- **Admin Pin:** A 6-digit numerical PIN used for administering the terminal configuration via the on-device touchscreen.
- **Function Pin:** A numerical PIN ranging from 1 to 6 digits that can be mapped to any function on the frogTerminal. For example, "111" could be designated to call security.
- **Access Pin:** A 6-digit numerical PIN associated with User Access Rules, granting access to doors or entry points as part of a two-factor authentication system that complements RFID cards or tags.

Note: Incorrect PIN entries will trigger a delay before the next PIN can be input. These delays increase incrementally (e.g., 5s, 10s, 20s, 30s, up to 60 seconds).

6.3. Graphical feedback for access events

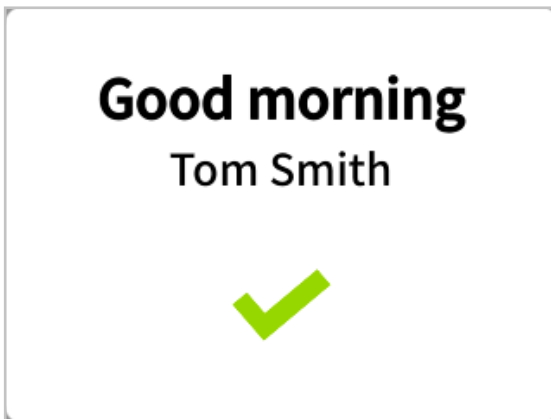

- A successful access event.

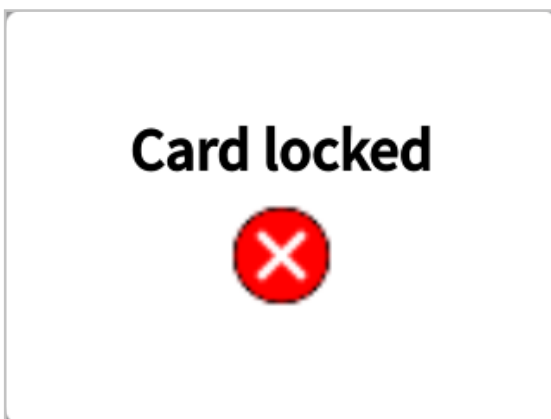

- A denied access event.

Wrong zone



- A denied access event.
- Reason: Card is not allowed access in this zone.

Access denied, wrong time



- A denied access event.
- Reason: Time Table exception. Card is not allowed at this time.

Wrong PIN



- A denied access event.
- Reason: PIN entered is invalid.

Card too old



- A denied access event.
- Reason: Card Issue date is invalid - card needs to be re-written/updated.



- Multi factor PIN required for access.
- Reason: Card or Zone requires additional access PIN. Depending on source setting enter users PIN or Terminal Zone PIN codes.

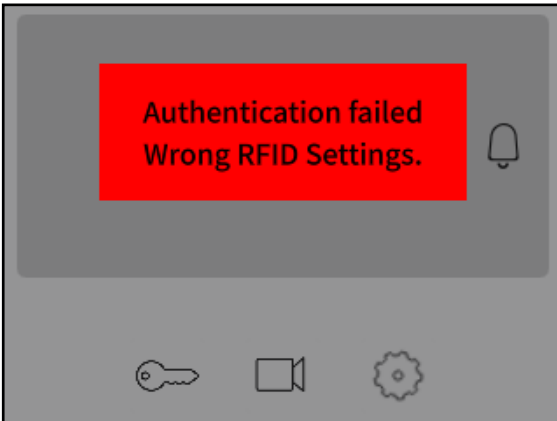

- The card is correctly formatted for frogblue.
- Project not written to card or wrong Project Number



- The card is correctly formatted for frogblue.
- Project not written to card or wrong Project Number

6.4. Decentralised Access Control

With frogblue, user data is stored directly on the cards or key fobs, making the system highly independent of networks or clouds. Each frogTerminal reads the complete user data from the card when presented, ensuring seamless operation without external dependencies.

To enable secure access across all terminals in a project, encryption settings must be consistent. This requires entering the same 10-digit PIN and project date on each terminal. Updates to user data, such as PIN changes or modified access permissions, can be made at a single terminal (e.g., at the main entrance). The updated data is then automatically written to the user's card during its next use. Card blocking is handled in the same way.

Future Enhancements: Upcoming updates will introduce the ability to manage user data remotely over the network or locally via Bluetooth. Additionally, a cloud-based access management system with time-tracking capabilities is planned.

6.5. Card Information

Each card securely stores essential user access details, including:

- User's name, first name, and personnel number
- Card creation date
- Validity period (start and end date/time)
- Personal PIN
- Weekly access schedules
- Access permissions for up to 9 zones

frogTerminals read and interpret the card's data directly. Any changes, such as new PINs or access schedules, are detected and seamlessly integrated during card usage. The terminal archives the card's content and usage timestamp, enabling administrators to view user details and access logs on the terminal display. If a network connection is available, this data can also be accessed remotely via a web browser.

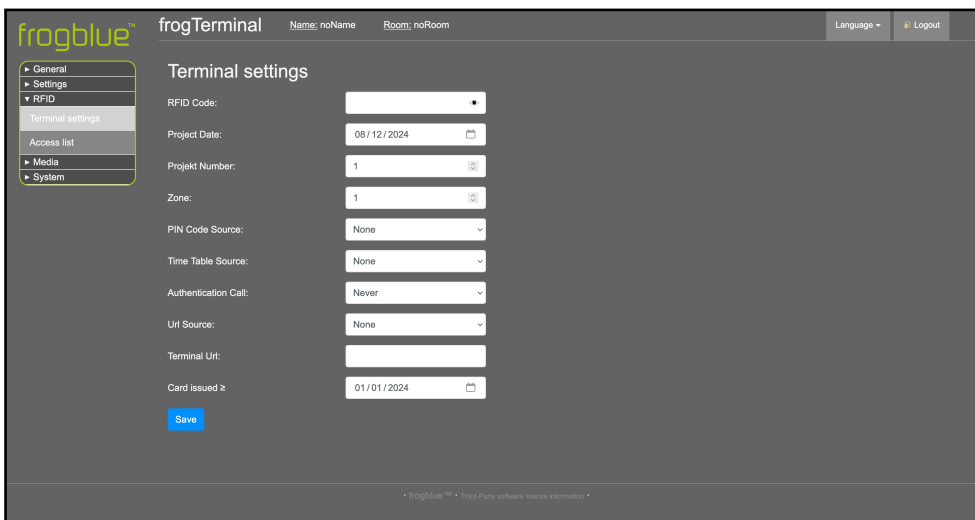

6.6. Access Functions

The card or key fob defines the user's access rules, such as PINs, schedules, and authorised zones. The system also allows flexibility for special situations:

- **No PIN Requirement:** For interior doors, the terminal can be set to bypass personal PIN validation (**NONE**).
- **Shared PIN:** For temporary security needs, a terminal-specific PIN (**TERMINAL**) can be set, overriding the personal PINs for all users.
- **Access Times:** Terminals can use access times stored on the card (**CARD**), set local schedules for all users (**TERMINAL**), or disable time restrictions entirely (**NONE**).

6.7. Special Features

frogTerminals support additional functionality to meet unique requirements:

- **Phone Integration:** Cards can store a phone number, allowing the terminal to initiate a call after the card is read and authenticated.

- **IP Links:** An IP link can be stored on the card, enabling automated actions such as triggering special functions or integrating with third-party systems like time tracking after authentication.
- **Advanced APIs:** The frogTerminal API (application programming interface) provides for custom integrations making the terminal a powerful smart access control point and system interface for 3rd party solutions providers.

These features make frogTerminal a versatile solution for advanced access control and system integration.

6.8. RFID Encryption and Zones

Introduction:

Set up access control parameters like RFID encryption, zones, and project settings.

Steps Overview:

- Configure RFID encryption (10-digit code and project date).
- Assign the terminal to zones.
- Set user-specific or terminal-wide PINs and schedules.

6.8.1. RFID Encryption and Zones Via Web Browser (Terminal Settings)

Menu: Access Control → Terminal Settings

The screenshot shows the 'frogTerminal' web interface. The top navigation bar includes the 'frogblue' logo, the title 'frogTerminal', and user information 'Name: noName' and 'Room: noRoom'. On the right, there are links for 'Language' and 'Logout'. The left sidebar contains a menu with the following items: General, Settings, RFID, Terminal settings (highlighted), Access list, Media, and System. The main content area is titled 'Terminal settings' and contains the following configuration fields:

- RFID Code: [Dropdown menu]
- Project Date: 08/12/2024 [Calendar icon]
- Projekt Number: 1 [Dropdown menu]
- Zone: 1 [Dropdown menu]
- PIN Code Source: None [Dropdown menu]
- Time Table Source: None [Dropdown menu]
- Authentication Call: Never [Dropdown menu]
- Urf Source: None [Dropdown menu]
- Terminal Urf: [Text input field]
- Card issued: 01/01/2024 [Calendar icon]

A blue 'Save' button is located at the bottom left of the form. At the bottom of the page, there is a small footer: '• frogblue™ • Third-Party software license information •'.

- **Main Key:** 10-digit numerical code used with the Project Date and Project Number as the foundation (or “seed”) for encrypting your access control setup. Frogblue devices commissioned with the same code, date, and project number operate as a unified system.
- **Project Date:** The timestamp used as a security seed, typically set to the last date on which this project was commissioned.
- **Project Number:** A number between 1 and 32,767 used to identify the project, useful in managing multiple projects or complex setups.
- **Zone:** A number from 1 to 9 that defines the access zone. The system supports up to 9 zones, each representing a specific access area (e.g., Carpark, Building A, Server Room, Security, etc.).
- **PIN code Source:** Determines the source of stored PIN codes for two-factor authentication, with 3 options:
 - **None:** Disables PIN entry at this terminal.
 - **Card:** The most common setting, enabling two-factor authentication with specific PIN codes assigned to individual users and stored on the access card.
 - **Terminal:** Secures the door or access point with a terminal-specific PIN code. This PIN applies to all users at this location, overriding personal PINs.
Selecting the Terminal option shows an additional input box enabling you to set a 6-digit PIN for access at this Terminal.
- **Time Table Source:** Specifies the source for time-based access rules, with 3 options:
 - **None:** Disables time-based access rules at this terminal.
 - **Card:** Time rules are stored on the access card, allowing individual schedules (e.g., General Staff: 9 a.m.-5 p.m., Cleaners: Fri-Sat 3 p.m.-7 p.m., Security: 24h).
 - **Terminal:** With this setting a door or access point may also be secured with a terminal-specific Time Table. Access times at this location are exactly as set locally in the Terminal.

Selecting the Terminal option shows an additional button for configuring the Terminal specific Time Tables. See Section 6.9 „Adding and Blocking Cards” on configuring Time Tables.

- **Authentication Call:**

This setting determines whether the terminal should initiate an authentication phone call to confirm access, such as verifying delivery access with dispatch, coordinating a contractor's entry with site management, or enforcing the four-eyes principle for security.

There are 4 configuration options:

1. **Never:** Disables authentication calls for all access events at this terminal.
 2. **Card Value:** The call settings (whether to call and whom to call) are defined and stored on the access card, allowing individualised configurations for users.
 3. **Only Exception:** Calls are made only for exceptional cases, such as access attempts outside defined time schedules or after incorrect PIN entries.
 4. **Always:** An authentication call is initiated for every access event, regardless of time schedules or PIN correctness, ensuring maximum oversight.
- **URL Source:** This setting determines whether the terminal should trigger an IP call or invoke a third-party API during access events. This feature enables integration with external systems, such as triggering special functions, logging access events, or interacting with third-party applications.

Examples include:

Logistics: Notify warehouse automation systems to prepare or dispatch an order upon access. Automatically light a path to the delivery gate for efficient navigation.

Healthcare: Trigger nurse call or management systems to log patient visitor details or confirm the delivery of critical medication.

Building Automation: Activate lighting and adjust HVAC settings along a defined route for the user, or automatically call an elevator to the correct floor.

Workforce Management: Log staff check-in/check-out times for attendance tracking or initiate a workflow when a technician accesses a specific area.

Security and Monitoring: Notify a security team or system when a restricted zone is accessed, or log entries for audit purposes.

There are 3 configuration options:

1. **None:** Disables URL triggering for access events at this terminal.
 2. **Card:** The URL to be triggered is defined and stored on the access card, allowing customised actions for individual users.
 3. **Terminal:** A specific URL is set locally on the terminal and triggered universally for all access events at this location. This setting is ideal for standardised integrations across multiple users.
- **Terminal URL:** The URL triggered when the **URL Source** setting is configured as **Terminal**. This allows the terminal to initiate standardised API calls or IP actions for all access events.
 - **Card Issued \geq :** Specifies the earliest creation date for cards allowed access at this terminal. Cards issued before this date are automatically denied.

This setting provides for a simple security measure in case of a potential breach (e.g., lost access keys) just set this date to the current day, all older cards are immediately blocked, all personnel must now present their keys for re-writing with updated credentials.

- The  button saves the updated access settings to the terminal.

6.8.2. RFID Encryption and Zones Via On-Device Touch Screen.



- Tap  and enter your 6-digit Admin Pin to access the configuration mode.

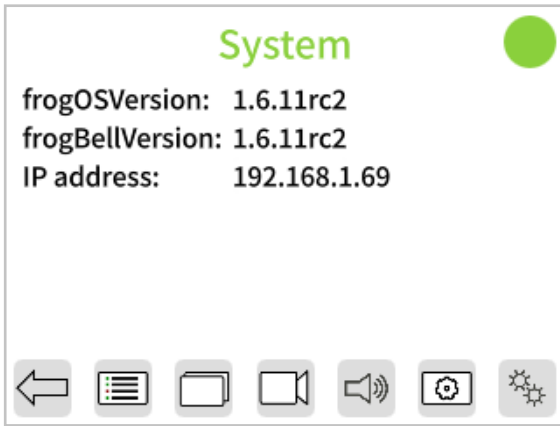

- Tap  to access the RFID Terminal settings page.

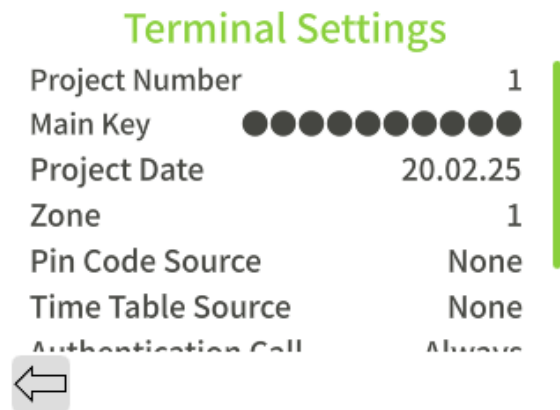

The settings on this page are identical to the settings in the Browser detailed in this section 6.8.2 , "RFID Encryption and Zones Via On-Device Touch Screen".

6.9. Adding and Blocking Cards

Introduction:

How to add RFID cards or key tags for user access and manage blocking when necessary.

Steps Overview:

- Add a card via touch screen or web interface.
- Assign access zones and schedules.
- Block a card.



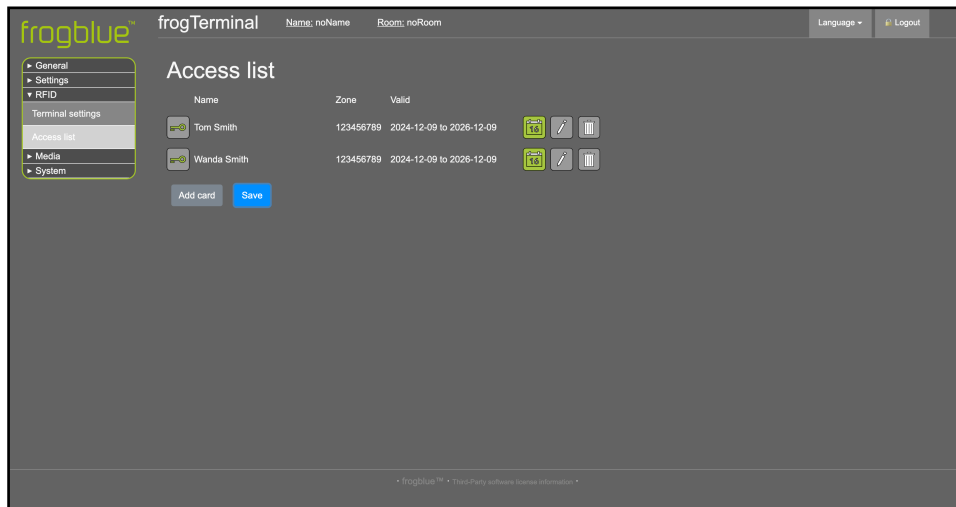

6.9.1. Adding and Blocking Cards Via Web Browser

Menu: Access Control → Access Rules



Not yet fully functional. Full RFID setup via web browser coming soon via software update.



Access List

- This section displays the access list, detailing the personnel whose access data is stored on this terminal.
- The  button toggles master access for this user. A green icon indicates access is allowed, while a red icon indicates it is denied.
- The  button opens the timetable configuration for the user. Refer to the Time Table Setup in the next section for details on configuration.
- The  button opens the card settings for customisation. See the **Edit Card Dialog** section for more information.
- The  button deletes the user's access configuration entry from this terminal.

Note: This does not block the card from accessing the system. It only clears the cached personnel card data on this terminal. A card written with the correct encryption key can still authenticate and gain access if the source settings allow. In such cases, the card will 'carry' the data to the terminal, creating or updating an entry in the access list with the card's details.

- The  button allows you to manually add a new personnel card entry to the system.
- The  button saves the updated access settings to the terminal.

Note: For systems with multiple terminals, new or updated access information is distributed either decentralised via the card when presented to a terminal during the next access event, or in real-time via frogCast (Unified Bluetooth/IP Mesh) across the IP network.

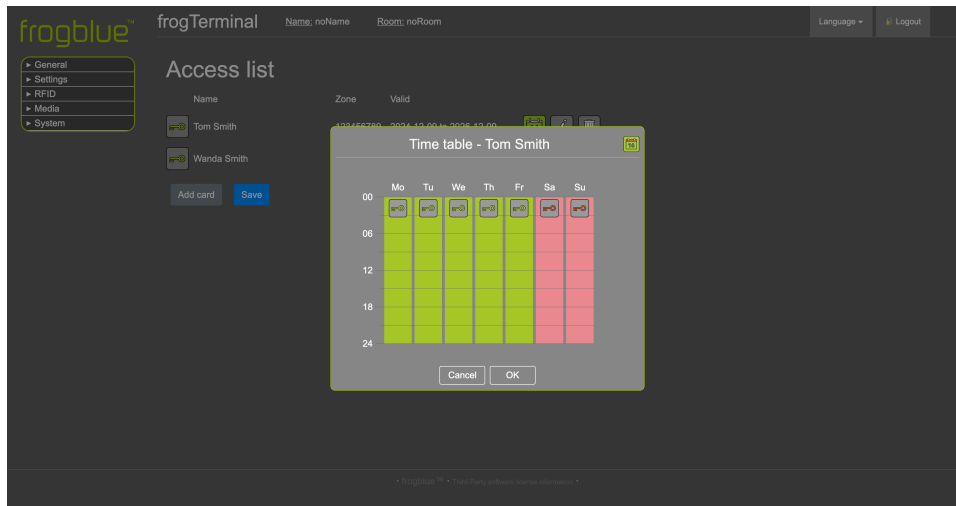

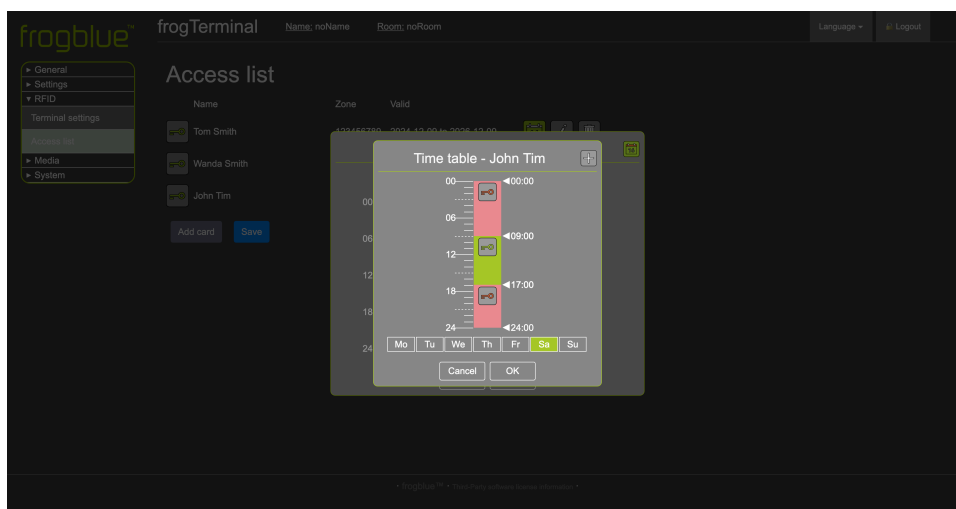

Time Table Setup

- The  allows you to enable or disable access for specific sections of the timetable. For example, clicking the key buttons for **Sa** and **Su** will turn the sections for Saturday and Sunday red, indicating that access is now denied on weekends.
- Clicking on a green or red day section of the timetable opens the **Time Table Day Setup Dialog** for the selected day.
- Day sections can also be dragged and dropped to copy time settings from one day to others.



Time Table Day Setup Dialog

- The  button toggles access for the relevant time frame. A green icon indicates access is allowed, red indicates access is denied.
- The  button opens the **Time Table Day Dropdown Dialog**, enabling you to add additional time frames for more granular control. For example, you can configure access to be denied after hours but allowed from 9 a.m. to 5 p.m. during working hours.

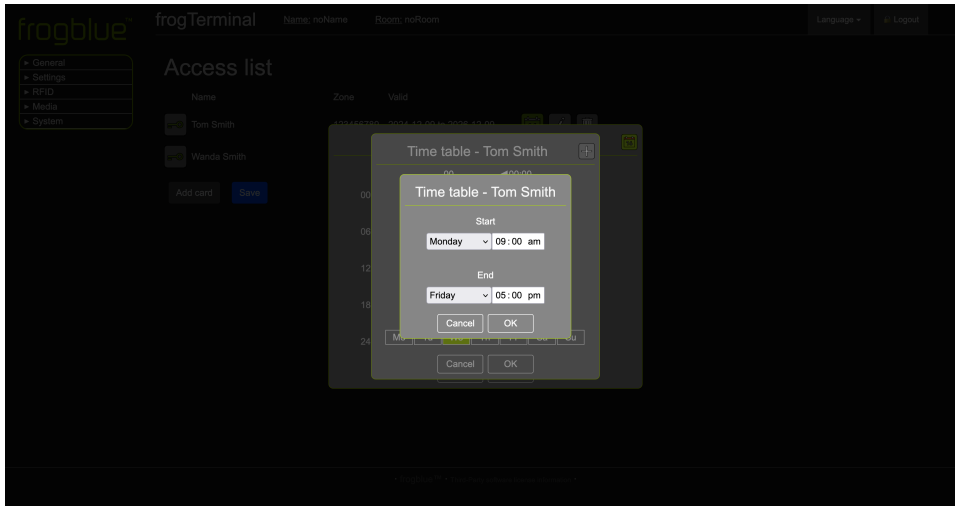

Time Table Day Dropdown Dialog

- In this dialog, you can configure custom time frames for your timetable, such as 9 a.m. to 5 p.m.
- Time frames can also span multiple days, such as Monday to Friday, 9 a.m. to 5 p.m., providing flexibility for recurring schedules.

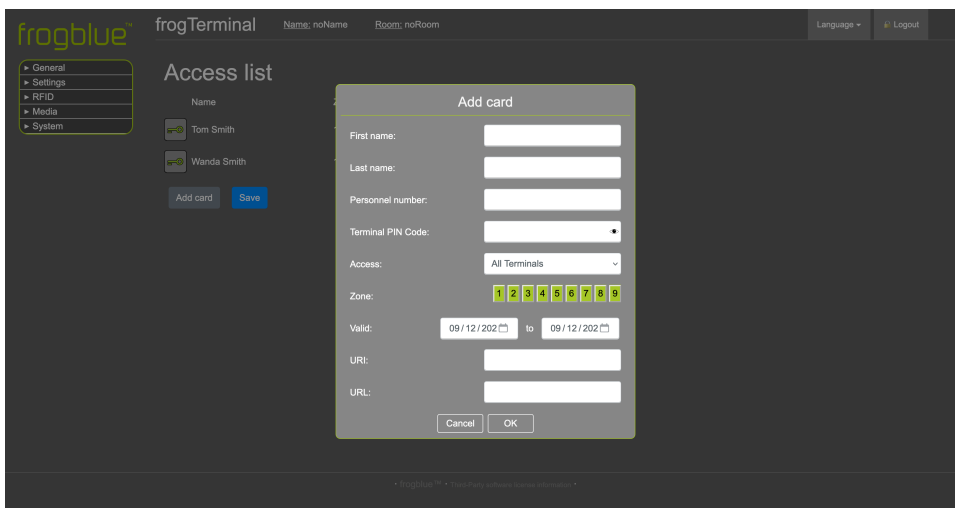

Add Card Dialog

- **First name:** The given name of the person associated with this card.
- **Last name:** The surname of the person associated with this card.
- **Personnel number:** A unique number or identifier for the person associated with this card.
- **Terminal PIN Code:** The unique access PIN code for the person associated with this card. This code is required when **Terminal Settings - > PIN Code Source** is set to **Card**.
- **Access:** Specifies whether this entry applies only to this terminal or to all terminals in the project.

- **Zone:** Specifies the zones this card grants access to. Clicking on the numbers **1** through **9** toggles whether access is allowed or denied for each zone. For example, selecting **3**, **6**, and **9** grants access only to zones 3, 6, and 9.
- **Valid:** The date range during which this access entry is valid.
- **URI:** The URL triggered in case of an exception, such as an access denied event.
- **URL:** The URL triggered on successful access.

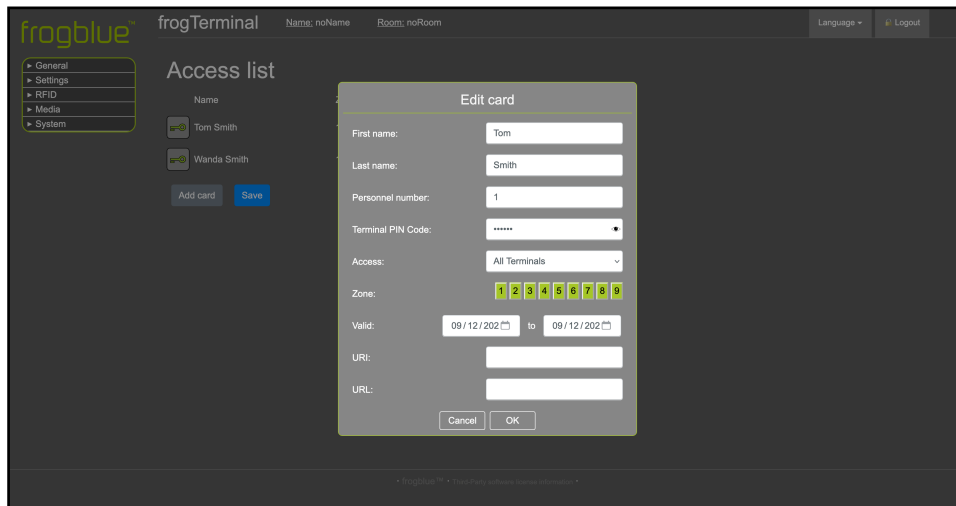

Edit Card Dialog

This dialog mirrors the **Add Card Dialog** settings, except it edits the configuration for the selected entry.

6.9.2. Adding and Blocking Keys / Cards Via On-Device Touch Screen

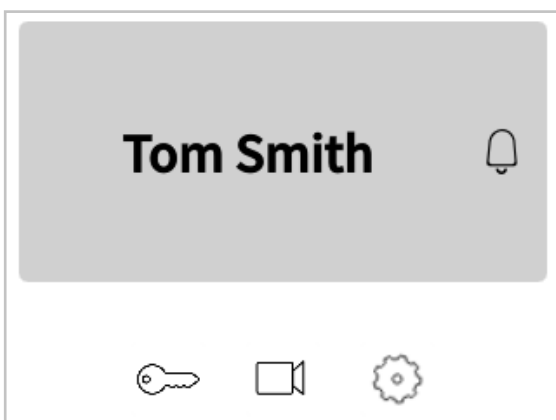

- Tap  and enter your 6-digit Admin Pin to access the configuration mode.

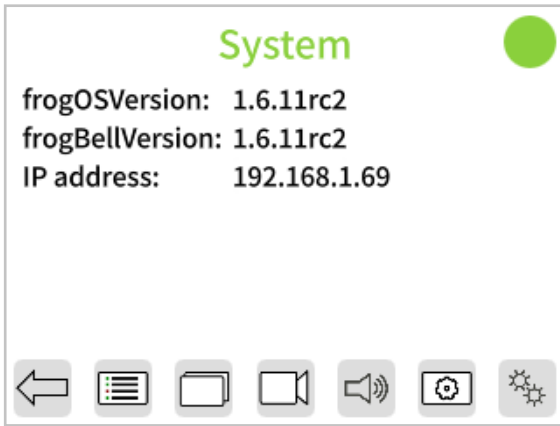

- Tap  to access the access rules settings page.

Accounts



- Tap  to add an access rule entry.

Note: The add card dialog is identical with the Edit Card dialog.

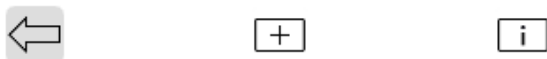

- **Active:** Enable or disable this card for access across the project. When set to off this card will be automatically blocked when presented to a the Terminal.

Edit Rule

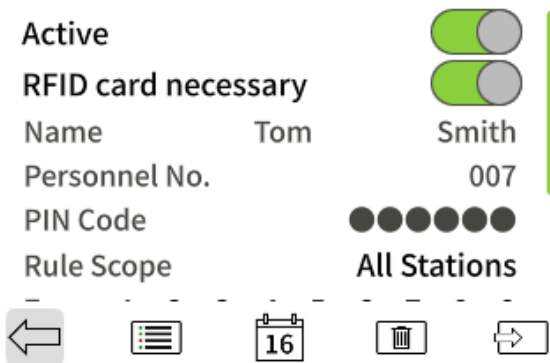

- **RFID Card necessary:** Defines if a RFID card or key is necessary for access with this user rule.
- **Name:** The given name (first field) and surname (second field) of the person associated with this card.
- **Personnel number:** A unique number or identifier for the user associated with this card.
- **PIN Code:** The unique access PIN code for the person associated with this card. This code is required when **Terminal Settings - > PIN Code Source** is set to **Card**.
- **Rule Scope:** Specifies whether this entry applies only to this terminal or to all terminals in the project.

Edit Rule

Personnel no. UU /

PIN Code ●●●●●●





Rule Scope All Stations

Zone 1 2 3 4 5 6 7 8 9

Validity 20.02.25 to 20.02.27

SIP URI

URL http://

- **Zone:** Specifies the zones for this card allows access. Clicking on the numbers 1 through 9 toggles whether access is allowed or denied for each zone.
- **Validity:** The date range during which this access entry is valid.
- **SIP URI:** The SIP URI triggered when case of an exception, such as an access denied event e.g. <sip://sipuser@sipregistrar.net>
- **URL:** The URL triggered on an access event.

6.9.3. Reading & Formatting Keys / Cards

How to add RFID cards or key tags for user access and manage blocking when necessary.

Steps Overview:

- Add a card via touch screen or web interface.
- Assign access zones and schedules.
- Block a card.

6.9.4. Via Web Browser (RFID → Access list)

Not yet fully functional. Full RFID setup via web browser coming soon via software update.

6.9.5. Via On-Device Touch Screen

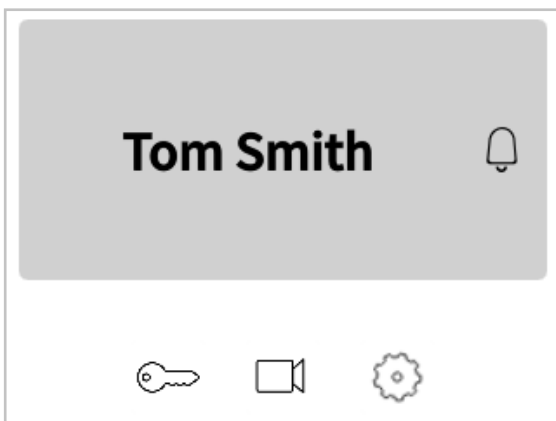

- Tap  and enter your 6 Digit Admin Pin to access the configuration mode.

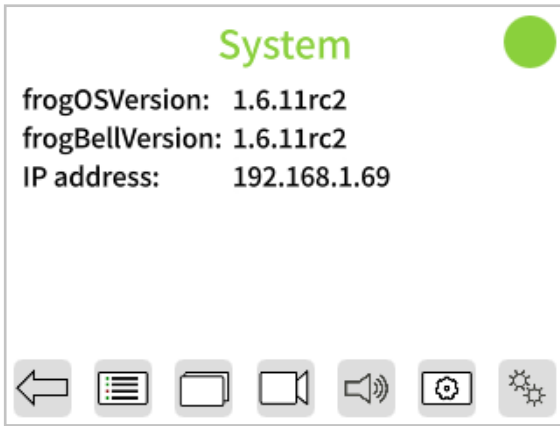

- Tap  to access the RFID key settings page.

Accounts



- Tap  to add open the RFID Card info dialog.

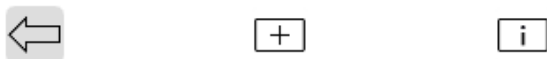

Card Info



- Hold your RFID card or tag in front of the Terminal's RFID sensor - just to the centre-left of the speaker.

Delete On Card

Applications on RFID card:



- This screen shows the Projects or Applications stored on the card or key.
- Select a project and tap Delete then confirm and hold the key / card in front of the Terminal to erase the project.
- To format a card back to factory defaults tap Format.

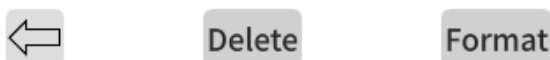

Format Card

Do you really want to
erase all data on the
card?



- Confirm you wish to completely erase all data on the card.

Format Card

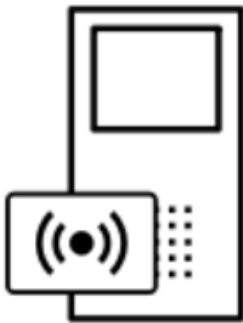

- hold the key / card in front of the Terminal, wait for the beep confirmation sound and your card has been formatted to defaults.





7. Telephony Call Destinations Setup

7.1. Bell Signs / Ring Buttons

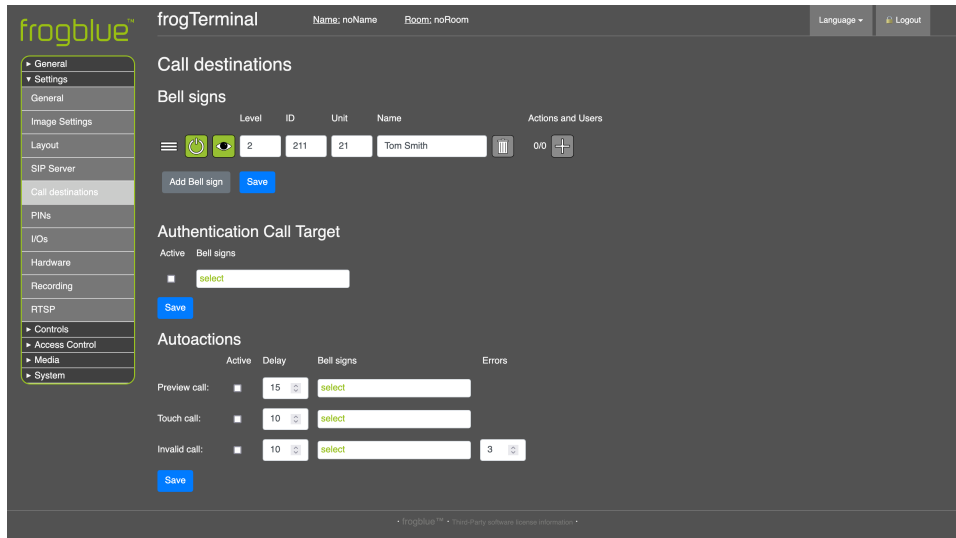
Via Web Browser Menu: Settings → Call destinations

Here we set up the Bell Signs, “Ring” or “Call” Buttons which appear on the Terminals touch screen when activated e.g. by touch or the proximity sensor.



- Click **Add Bell Sign** to create a new Call Button. A new entry will appear in the Bell Signs list.
-  Adjust the position of the entry in the list and set the default order in which the buttons appear on the terminal's touchscreen.
-  Enabling the entry makes it visible on the touchscreen and available as a call target. Disabling it removes it from the touchscreen and prevents it from being used as a call target.
-  Choose whether to hide or show this entry on the terminal's touchscreen display. Hidden entries can still function as call targets programmatically (e.g., via APIs) or for authentication calls.
- **Level (Optional):** The floor level for the entry (i.e. '2').
- **ID (Optional):** An identifier for this entry (e.g., '211' could represent level 2, unit 21, person 1).
- **Unit (Optional):** Specifies the Apartment or Unit number (i.e. '21').
- **Name:** The display name for the entry on the touchscreen call button (i.e., 'Tom Smith').
-  Deletes the bell sign entry.
- **Actions and Users:** Defines the actions triggered when a bell button is tapped or activated. Use the  button to add a new action entry. The numbers shown indicate the current selection and the total number of actions for this bell sign entry (current/total).

Bell actions can be stacked using various parameters—such as time tables and delays—to execute different actions at designated times or in sequence. Further enhancements to the action and event system are currently in development.

Hitting the  button opens a dialog where we can choose from a number of Action types using the drop down menu:

7.1.1. Bell Actions: Invite frogSIP user

Here you can pair your Terminal with smartphones running the frogSIP App.

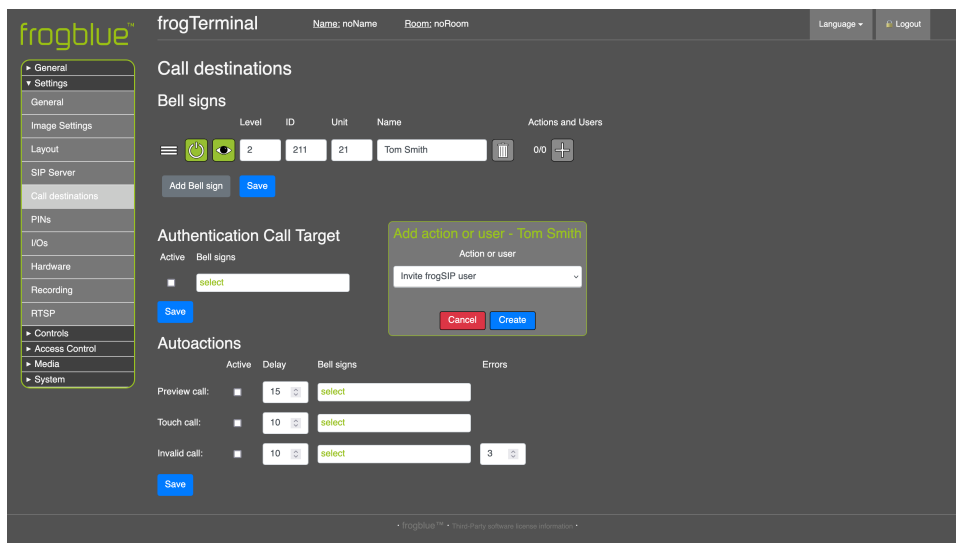

- Select **Invite frogSIP user** from the drop-down menu
- Click **Create** to create a new pairing invitation for a frogSIP App connection.

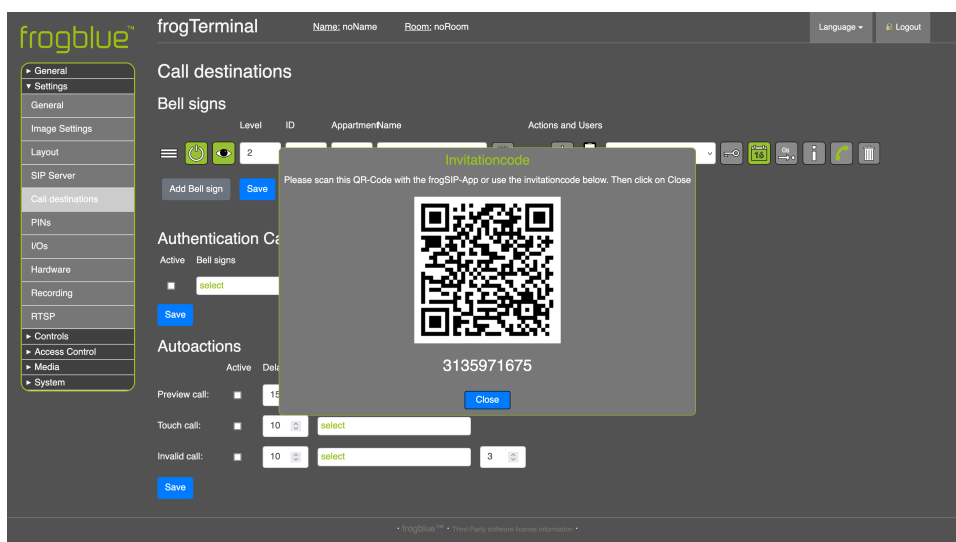

- Scan the QR code or the enter invite code in the **frogSIP App**. See section **5.6 Pairing the Terminal with frogSIP App**

7.1.2. Bell Actions: Direct SIP calls by IP

For directly calling SIP telephony devices via IP.

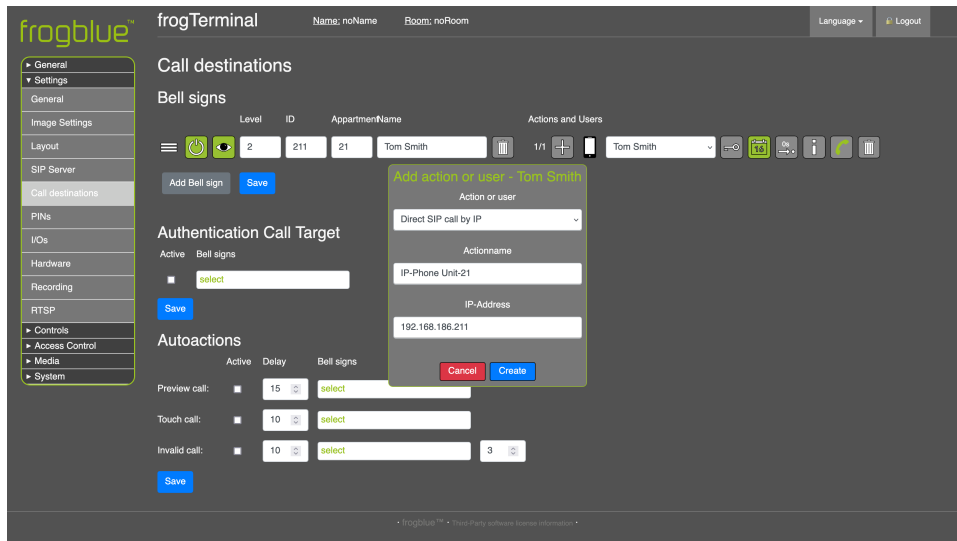

- Select **Direct SIP call by IP** from the drop-down menu.
- **Action name:** Enter a name for the action i.e. **IP-Phone Unit 21**.
- **IP-Address:** The IP Address of the SIP phone device to call.
- Click **Create** to create a new Direct SIP call by IP action.

7.1.3. Bell Actions: SIP calls via SIP Server

When configured with a SIP server, calls can be made to any phone on the system. The SIP server must be configured first - see Section 17.2. „SIP Server Registration“, for details.

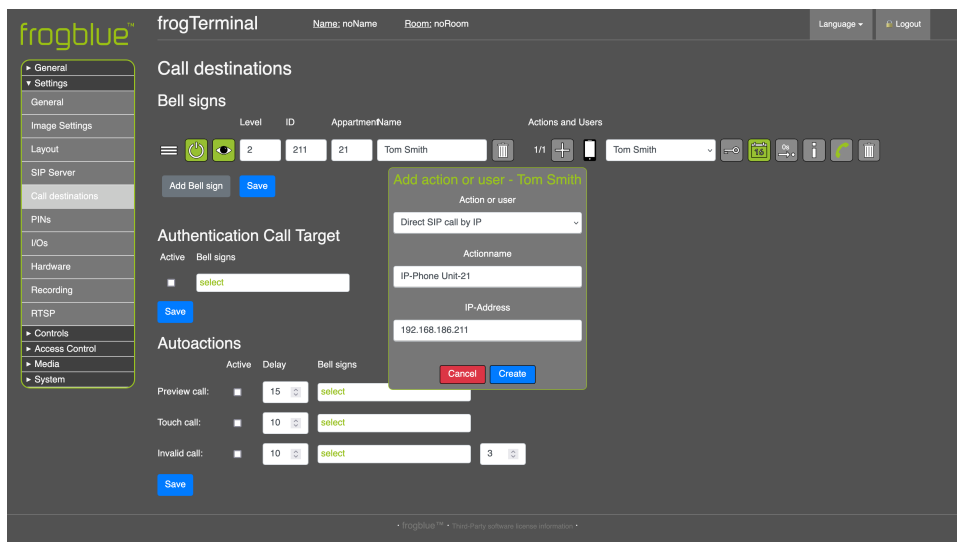

- Select **Direct SIP call by IP** from the drop-down menu.
- **Action name:** Enter a name for the action i.e. 'IP-Phone Unit 21'.
- **IP-Address:** The IP Address of the SIP phone device to call.
- Click **Create** to create a new Direct SIP call by IP action.

7.1.4. Bell Actions: Send frogMessage

This feature enables seamless integration with frogBlue's smart automation mesh, allowing for automated control of lights, doors, and shutters. It requires provisioning your frogTerminal for frogMesh integration see Section 16.

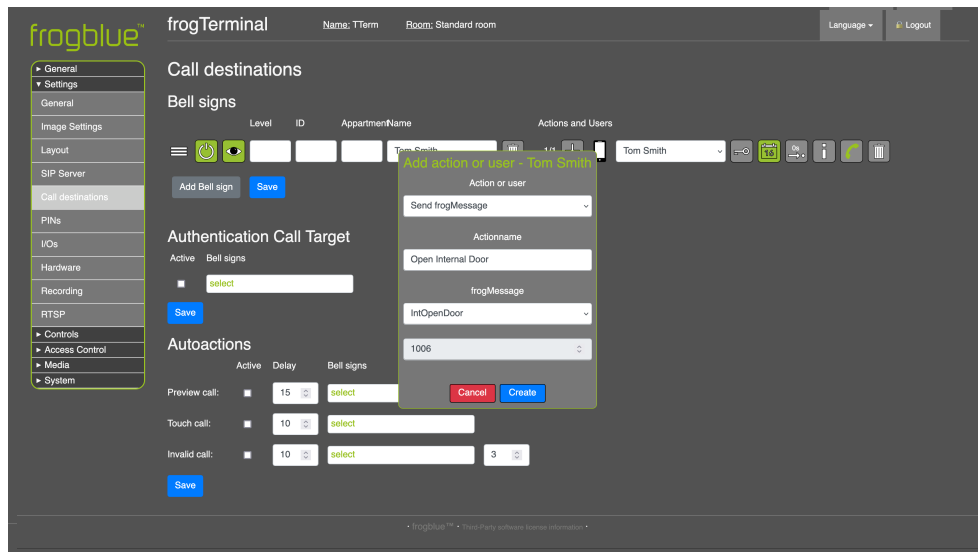

- **Action or user:** Select **Send frogMessage** from the drop-down menu.
- **Action name:** Enter a name for the action i.e. **Open Internal Door**.
- **frogMessage:** Select the frogMessage you wish to send from the drop-down menu.

7.1.5. Bell Actions: Trigger Relay (hardware)

This feature enables you to directly trigger the frogTerminal's built-in hardware relay. For example, a bell button can be configured to activate an external light or another system via the relay.

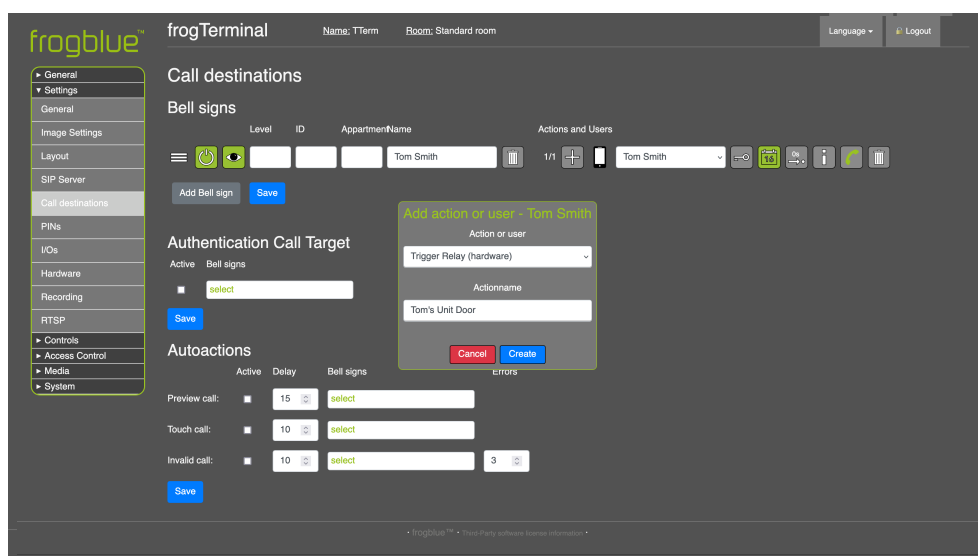

- **Action or user:** Select **Trigger Relay (hardware)** from the drop-down menu.
- **Action name:** Enter a name for the action i.e. **Tom's Unit Door**.

7.1.6. Bell Actions: Start opener sequence

This feature allows you to trigger predefined opener sequences or home objects, offering advanced control over multiple entry points. For example, you can configure the system to open a gate and then, after a set delay (e.g., 20 seconds), automatically open a garage door. This functionality enhances automation by streamlining sequential access events.

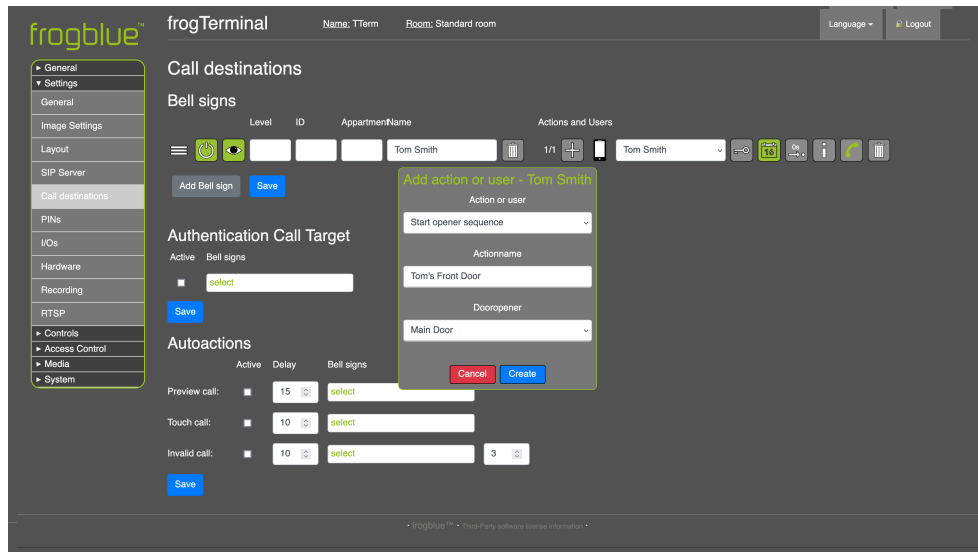

- **Action or user:** Select **Start opener sequence** from the drop-down menu.
- **Action name:** Enter a name for the action i.e. **Tom's Front Door**.
- **frogMessage:** The IP Address of the SIP phone device to call.

7.1.7. Bell Actions: Send IP-Notify

This feature enables seamless integration with third-party IP devices, allowing a bell button to send network notifications that can trigger external systems such as an IP gate opener.

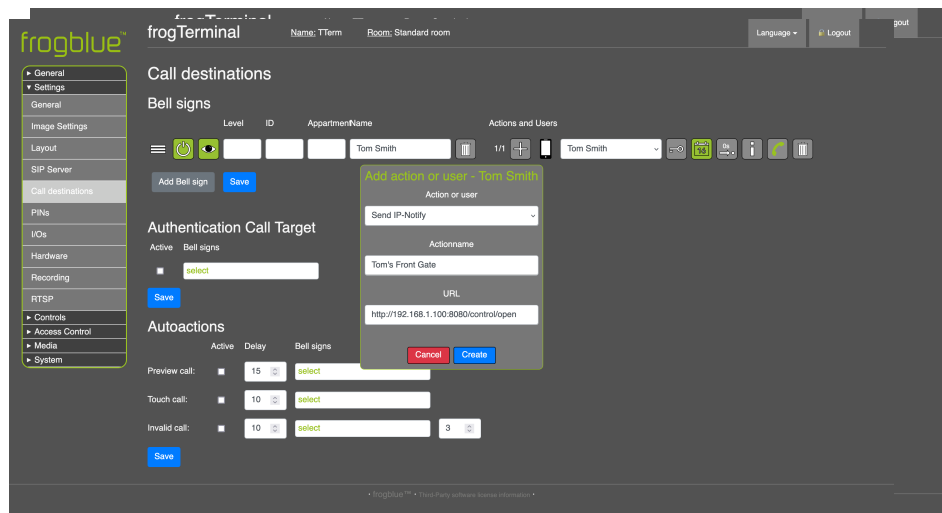

- **Action or user:** Select **Send IP-Notify** from the drop-down menu.
- **Action name:** Enter a name for the action i.e. **Tom's Front Gate**.
- **URL:** The URL to trigger o this action where the IP Address is that of your Gate Opener device, 8080 the port, and /control/open the command it expects to open the gate.

7.1.8. Bell Actions: Show image

This feature displays a preloaded image, such as a company logo, on the terminal's screen when the bell button is pressed, enhancing brand visibility or providing a clear visual cue for users.

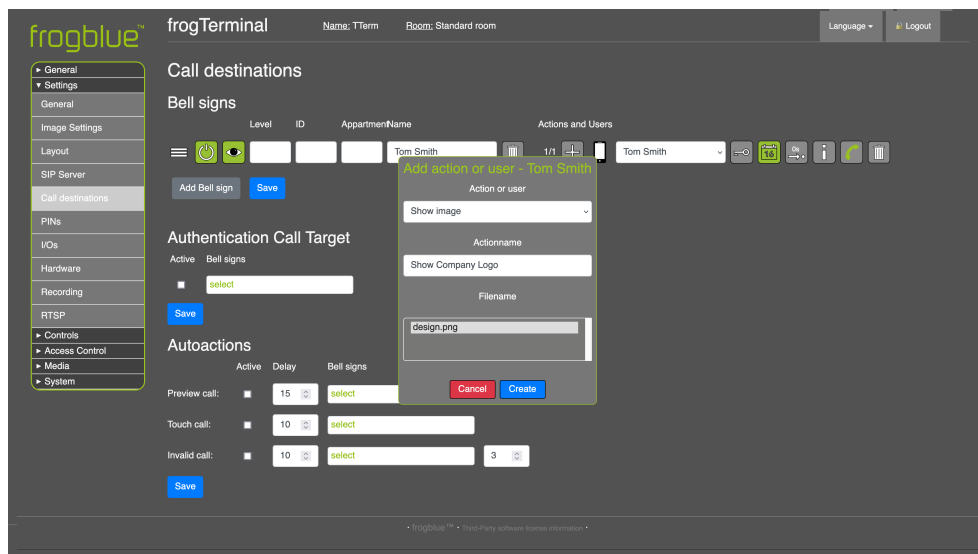

- **Action or user:** Select **Show image** from the drop-down menu.
- **Action name:** Enter a name for the action i.e. **Show Company Logo**.
- **Filename:** Select an image file that has been uploaded to the terminal. For further details, please refer to Section 15: „On-board Media Settings“.

7.2. Authentication call Target

Configure the target for **multi-factor authentication calls**. This call is initiated during an Access Event when the Authentication Call is triggered based on the defined Access Rule.

7.3. Auto actions

Define the call targets for events or errors at the Terminal:

- **Preview call:** Initiated when the proximity or motion sensors are triggered for the specified Delay period and no action is taken e.g., a **loitering event**.
- **Touch call:** Initiated when the touch screen is activated for the specified Delay period without any valid function being executed e.g., **suspected tampering**.
- **Invalid call:** Initiated when the number of errors exceeds the configured threshold e.g., three **consecutive incorrect PIN entries** or an **unrecognised card / key scan**.

8. Camera Settings and Recording Management

8.1. Configuring the Camera Image Settings

Via Web Browser Menu: Settings → Image Settings

Adjust camera settings for optimal video quality and coverage.

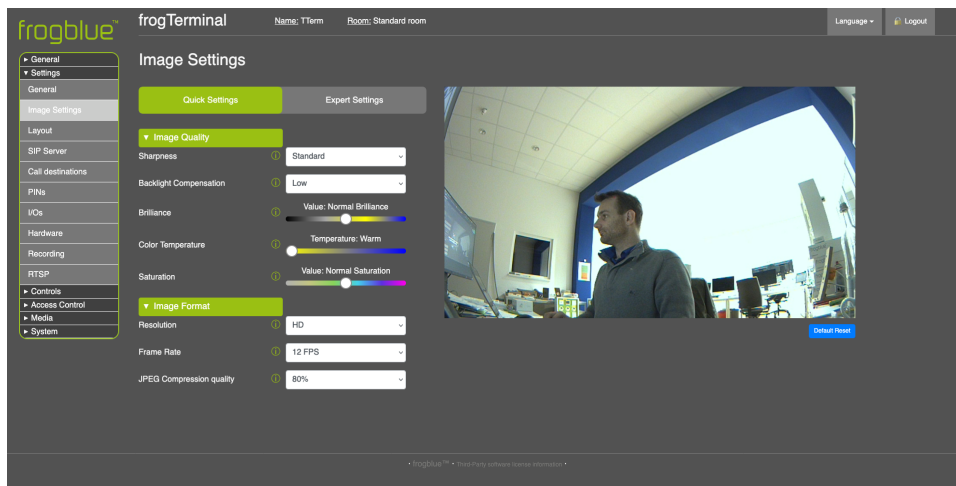

Image Quality:

- **Sharpness:** Increases the clarity of edges and fine details, giving the image either a more defined, crisp or or a more smoothed look.
- **Backlight Compensation:** Adjusts the intensity of the backlight to improve visibility in dark environments or to reduce glare in bright scenes.
- **Brilliance:** Adjusts overall contrast and vividness, making colours and details stand out more.
- **Colour Temperature:** Adjusts the warmth or coolness of the colours in the image, balancing the colour tones based on the environment (e.g., sunlight or fluorescent lighting).
- **Saturation:** Controls the intensity of colours, allowing adjustments to make colours appear more vibrant or subtle.

Image Format:

- **Resolution:** Determines the level of detail in the image and sets the clarity and pixel density of the video output.
- **Frame Rate:** Controls or limits the number of frames per second, affecting the fluidity and smoothness of the video.
- **JPEG Compression quality:** Quality setting for the underlying JPEG compression.

8.2. Optimal Settings for Low Latency & High Frame Rate

To achieve the best low-latency performance and high frame rate, ensure that:

- **No browser-based HTTPS or web stream** is running (e.g., camera live stream in a browser).
- The following **image settings** are applied:
 - **Image Enhancement:** Set to Off.
 - **Image Resolution:** Set to maximum HD.
 - **JPEG Compression Quality:** Set to 60%.
- **On-board recording is disabled** for optimal performance. Instead, use a **VMS system** for video recording.

8.3. Event Recording Settings

Enable Configure manage event-based recordings.

Configure pre- and post-event snapshot settings.

Enable alert notifications for failed access attempts.

View and manage recorded events.

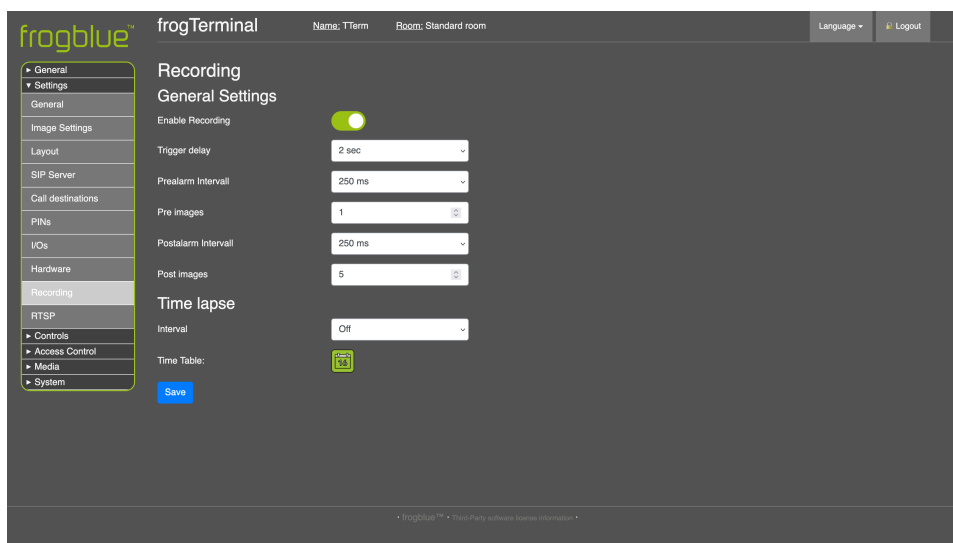

- **Enable Recording:** Toggle event recording on or off for the on-board SD Card.
- **Trigger Delay:** Set the delay between the event occurrence and the start of recording. This ensures that transient events, such as a bell press, do not capture an obstructive hand covering a significant portion of the image.
- **Pre-alarm Interval:** Define the period during which recording occurs before the event is triggered. This interval, which includes the trigger delay, allows you to capture footage preceding the event.
- **Pre Images:** Specify the number of images or frames to record prior to the event trigger.

- **Post-alarm Interval:** Set the duration for recording after the event trigger occurs.
- **Post Images:** Define the number of images or frames to capture after the event trigger.
- **Maximum retention period:** Set the maximum duration for storing recordings and logs before older data is automatically deleted using a ring-buffer mechanism.

Time lapse

- **Interval:** Set the interval between time-lapse images to capture periodic snapshots.
- **Time Table:** Specify the schedule for time-lapse recording—for example, recording only during daylight hours—to ensure optimal image capture.

9. Admin PIN & Function PINs

Via Web Browser Menu: Settings → PINs

Function PINs can be mapped to specific function allowing for example direct opening of a door, switching on all the lights in an area via frogMessage, or sending a silent alarm or security alert. Functions can be stacked much like with Call Destinations allowing for sequences or multiple actions e.g. Open door but also trigger a silent alarm.

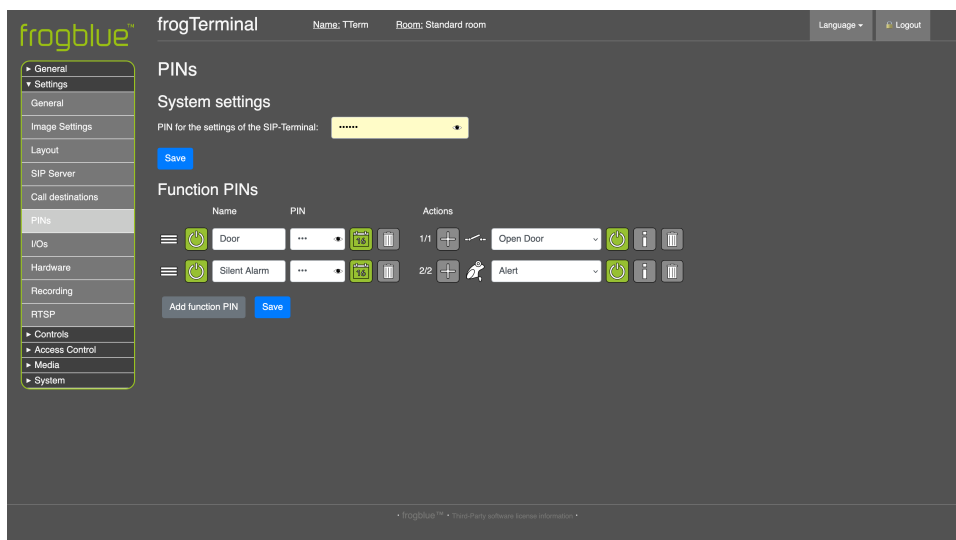

- **System admin PIN:** Specify an exact 6-digit PIN which is used to manage the frogTerminal via the on-device touchscreen to gain access to the local system settings.
- **Function PINs:** A function PIN must contain 1-6 numbers, the length of the PIN is freely selectable. Function PINs trigger stored functions, such as the local relay, or send messages via IP & Bluetooth

Function PINs currently support sending frogMessages, Triggering the built in Relay, Starting a door opener sequence, or sending IP messages or triggering 3rd party systems via HTTP msg.

10. Input / Output Settings

Via Web Browser Menu: Settings → I/Os

Setup the hardware inputs and relay output settings for your frogTerminal.

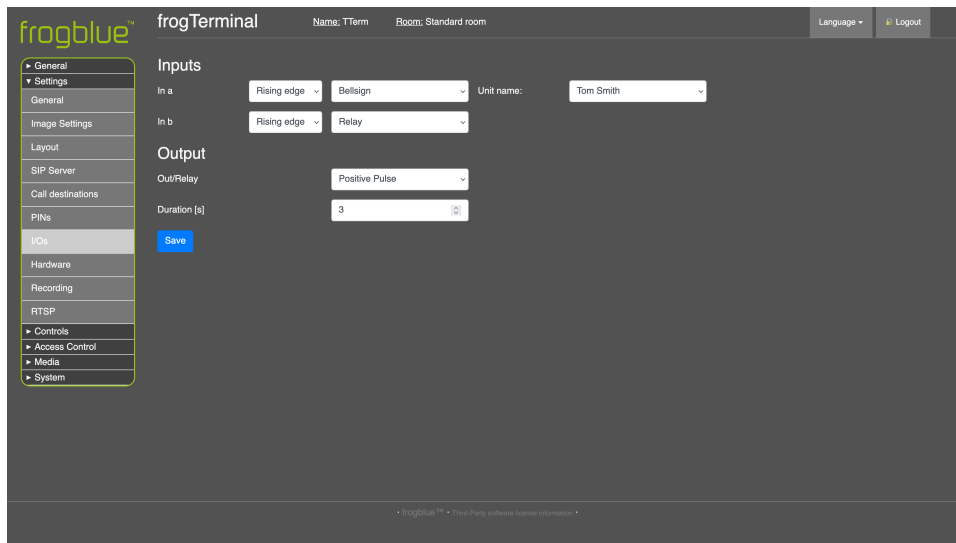

The screenshot shows the 'frogTerminal' web interface. The top navigation bar includes the 'frogblue' logo, the device name 'TTerm', the room name 'Standard room', and options for 'Language' and 'Logout'. A left sidebar menu lists various settings categories: General, Settings (expanded), General, Image Settings, Layout, SIP Server, Call destinations, PINs, I/Os (highlighted), Hardware, Recording, RTSP, Controls, Access Control, Media, and System. The main content area is titled 'I/Os' and is divided into 'Inputs' and 'Output' sections. Under 'Inputs', there are two rows: 'In a' and 'In b'. Each row has a dropdown for 'Rising edge', a dropdown for the action (currently 'Bellsign' for In a and 'Relay' for In b), and a 'Unit name' dropdown (currently 'Tom Smith'). Under 'Output', there is a dropdown for 'Out/Relay' (currently 'Positive Pulse') and a text input for 'Duration (s)' (currently '3'). A blue 'Save' button is located below the 'Duration' field. At the bottom of the page, there is a small link: 'frogblue™ frogblue software license information'.

Input Configuration (In a / In b): Configure the physical inputs A and B to trigger actions based on state changes

- **Rising edge:** Activates when the input transitions from low to high.
- **Falling edge:** Activates when the input transitions from high to low.

Select the Action for the Input:

- **Bellsign:** Choose the bell entry to trigger a call when this input is activated.
- **BT-Message:** Send a Bluetooth message via frogMesh.
- **Relay:** Activate the hardware relay.
- **IP Notify:** Send an IP message or HTTP request to a specified URL.
- **Play Sound:** Select an audio file (e.g., a bell sound) to play when the input is triggered.

Output: Set the physical relay output settings:

- **Out/Relay:** Choose between a positive or negative pulse.
- **Duration (s):** Define the duration, in seconds, to trigger the relay.



11. Hardware Settings: Proximity Sensor & Touchscreen Display

Via Web Browser Menu: Settings → Hardware

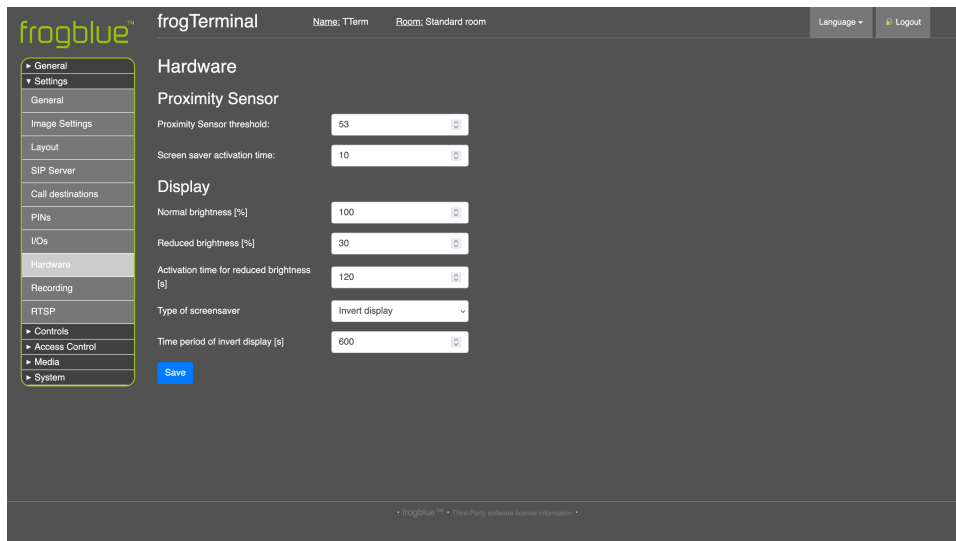
Configure the Terminals wake up and standby setting.



Proximity Sensor

- **Proximity Sensor Threshold:** This setting determines the sensitivity of the proximity detector, lower values mean higher sensitivity.
- To visualise the current detection level, navigate through the device's on-screen settings ( →  → ) to view a live graph of the proximity sensor readings.
- **Screen saver activation time:** Time in seconds of no activity when the terminal will automatically return to the screen saver or Home Screen.

Display

- **Normal brightness [%]:** This setting determines the brightness of the Terminals screen when activated e.g. by touch or proximity.
- **Reduced brightness [%]:** This setting determines the brightness of the Terminals screen when in standby mode.
- **Activation time for reduced brightness [s]:** Time in seconds after which the brightness is reduced and the Terminal is in standby waiting for a touch, movement, or other trigger to activate it.

12. Touchscreen Display Layout

Via Web Browser Menu: Settings → Layout

Configure the Home Screen Layout for the Terminals on device touchscreen.

The screenshot shows the 'Layout' configuration page in the frogTerminal web interface. The left sidebar contains a menu with options like General, Settings, Image Settings, Layout, SIP Server, Call destinations, PINs, I/Os, Hardware, Recording, RTSP, Controls, Access Control, Media, and System. The main content area is titled 'Layout' and includes the following settings:

- Address:** A dropdown menu for 'Display' set to 'Lines'. Three text input fields for 'Line 1' (frogblue studio), 'Line 2' (55), and 'Line 3' (1st Avenue).
- Display Style:** A dropdown menu for 'Display' set to 'Bell signs'.
- Display Settings:** A color picker for 'Bell Button Color'. Three toggle switches: 'Show Bell icon on Button' (on), 'Show button:' (on), and 'PINs' (on). A 'Save' button is located at the bottom left.

Address: The settings for the Standby Screen layout.

Display: The settings for the Home Screen.

13. General Terminal Settings

Via Web Browser Menu: Settings → General

Configure general settings such as the name, default ring settings, web admin password.

The screenshot shows the 'General Settings' configuration page in the frogTerminal web interface. The left sidebar is the same as in the previous screenshot. The main content area is titled 'General Settings' and includes the following settings:

- Name for the door/Vision:** Text input field containing 'Tom's Door'.
- Maximum ring duration:** Text input field containing '30'.
- Maximum call duration:** Text input field containing '300'.
- Show control icons during incoming call:** Toggle switch, currently off.
- Max autoanswer level for users:** Dropdown menu set to 'Automatic answering'.
- Allow callback shortly after missed ringing:** Toggle switch, currently on.
- Which sound on ringing:** Dropdown menu set to 'None'.
- Which sound on opening door:** Dropdown menu set to 'None'.
- Change admin password:** Three text input fields for 'Old Password', 'New Password', and 'Repeat new Password'. A 'Change Password!' button is at the bottom.

Settings

- **Terminal Name:** Enter the name for your frogTerminal i.e. **Tom's Door** to help identify the device within your system.
- **Maximum ring duration:** Set the maximum time the terminal will attempt to ring a callee before giving up.

- **Maximum call duration:** Set the maximum call time after which the terminal will automatically hang up.
- **Show control icons during incoming call:** Automatically display the toolbar when receiving a call (e.g., to enable or disable video).
- **Max autoanswer level for users:** Define the allowed level for automatic call answering:
 - **Decline:** Automatically decline all incoming calls.
 - **No:** Do not allow incoming calls; no SIP connections will be accepted.
 - **Automatic answering:** Enable automatic call answering. Note that individual user permissions must still be configured in the Call Destinations actions menu (click the "i" button next to a user's action entry to allow call answering at the terminal for that user).
- **Allow callback shortly after missed ringing:** After a call is missed, this feature permits the user or the called phone to call back and have the call automatically answered. It overrides other auto-answer settings and permissions.
- **Ring sound:** The sound played at the Terminal when a call is made.
- **Open door sound:** The sound played at the terminal when the door is opened - useful to alert the person the door is now open especially for silent door openers.

Change admin password

- **Web Admin Password:** Here you can change the web administrator password. Note you need to enter the old password and then twice repeat your desired new password before clicking **Change Password!**

14. Door Control Settings

Via Web Browser Menu: Controls → Door Opener

Configure the local door opener, "Homeobjects" and the control options of the frogSip app.

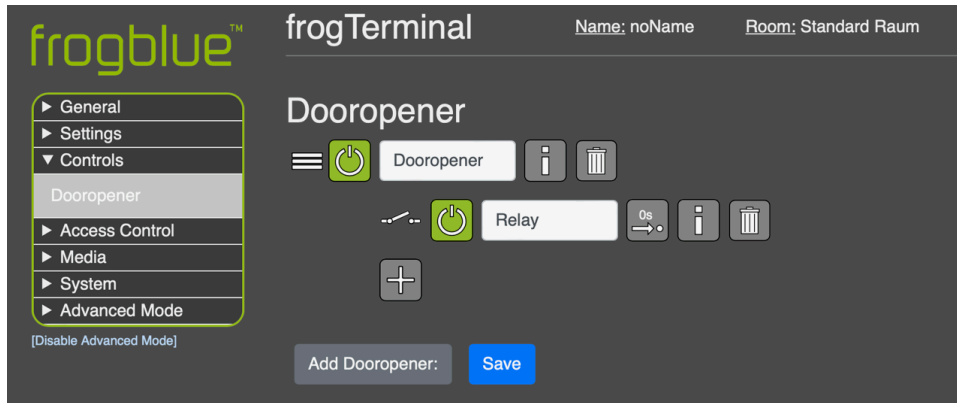

15. On-board Media Settings

Via Web Browser Menu: Media

Configure the settings of the visual and acoustic areas & manage the recordings of local events.

15.1. Audio files

Allows managing and uploading custom audio files which can be used in the frogTerminal e.g. for custom bell sounds, voice or sound notifications or alerts.

15.2. Image files

Allows managing and uploading custom image files which can be used in the frogTerminal e.g. for custom logos or user interfaces.

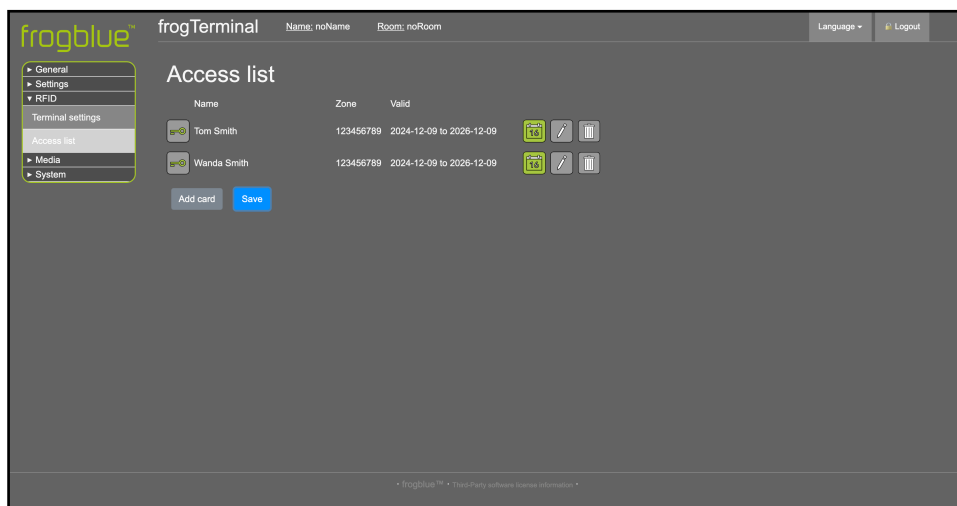

15.3. Video files

Allows managing and uploading custom video files which can be used in the frogTerminal e.g. for delivery instructions or automated site inductions.

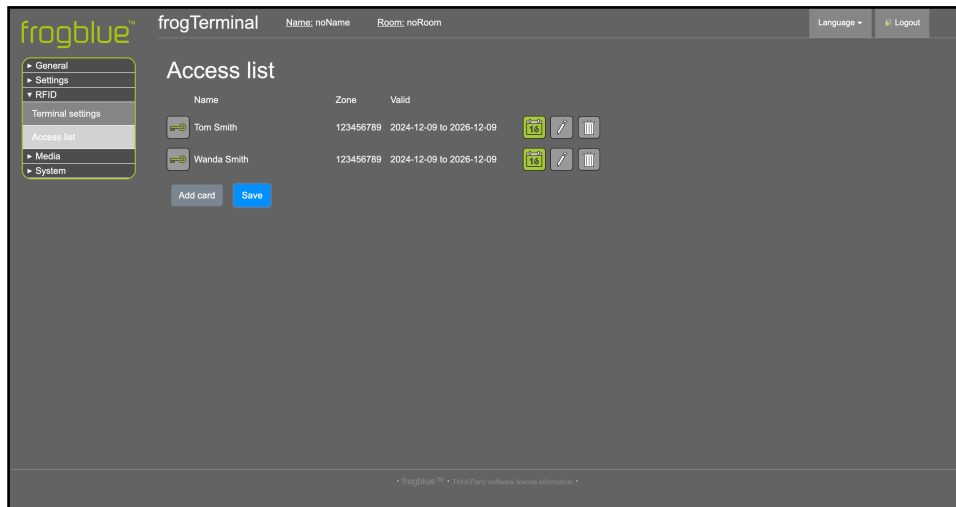



15.4. Stream list

Feature not yet fully implanted - support for external streams coming.

15.5. Event Pictures

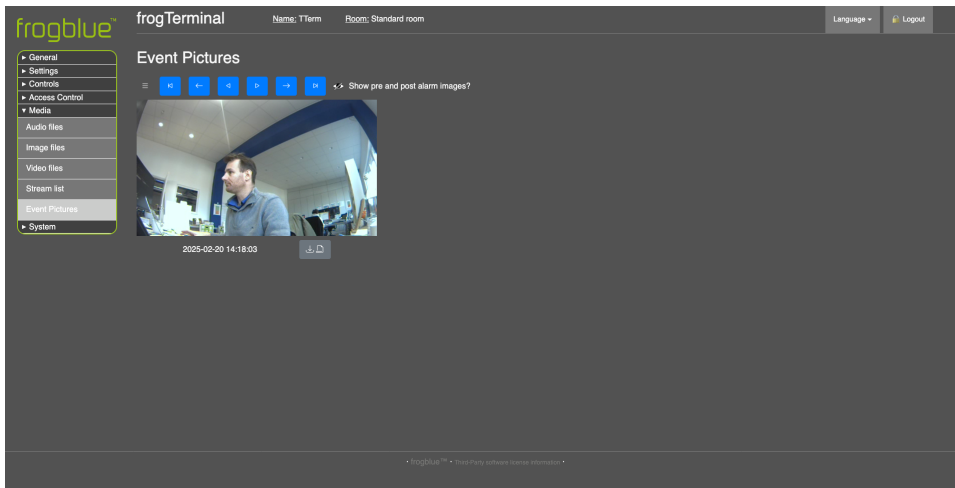
Allows searching, viewing, and downloading stored event images from the frogTerminal.



- Use the playback controls to find the event image you're looking for.
- Use the download button  to download high quality RAW format images to your computer or browser enabled device.

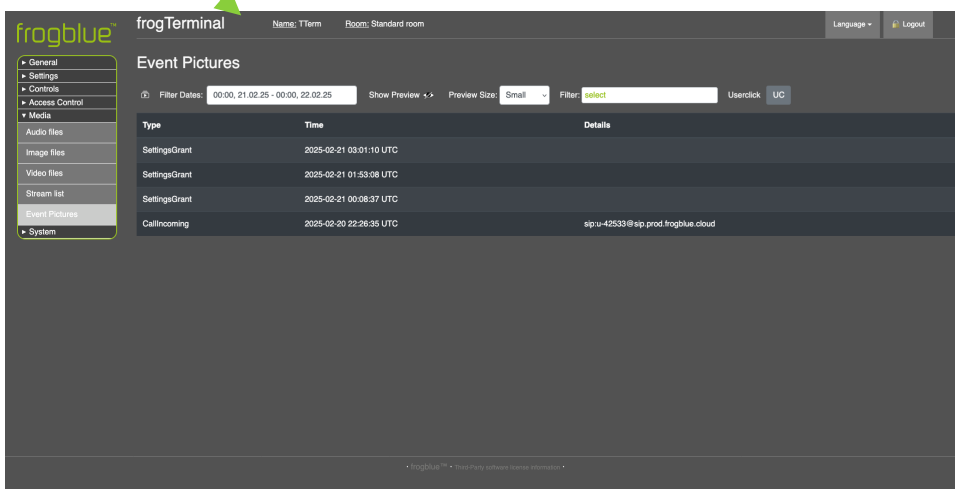
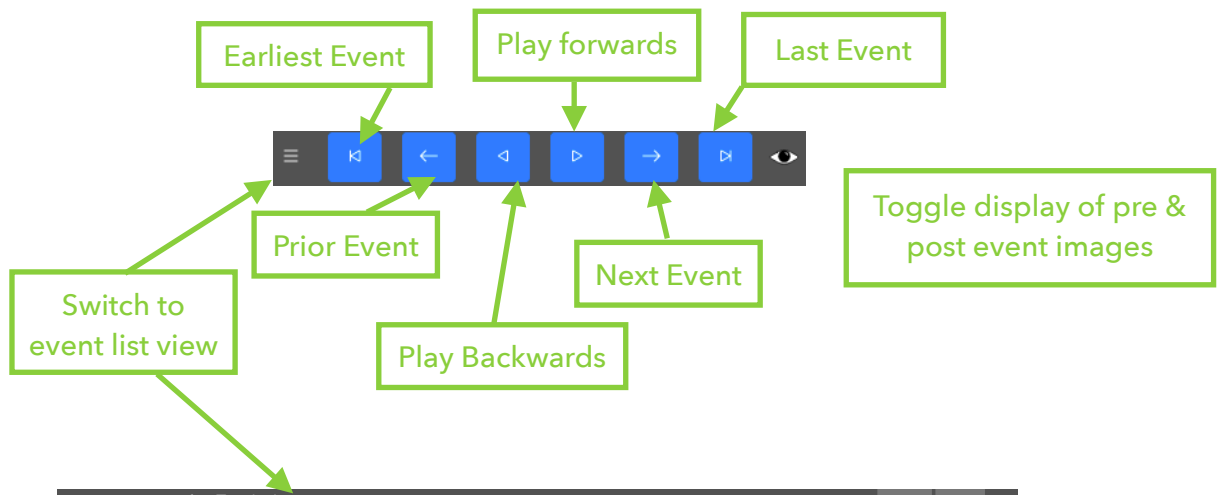

- Use the event list view to search and filter events by Time, Date, and Event Type
- **UC** Triggers a manual recording.

16. Configuring the frogTerminal for Automation via frogCast/frogMesh

Provisioning the frogTerminal with frogCast/frogMesh configuration enables seamless integration with frogBlue's smart automation mesh, allowing for automated control of lights, doors, and shutters.

First note down your frogTerminals **Bluetooth MAC-Address** from **Web Browser → General → Overview**.

- Open the **frogProject App** on your iPad or compatible device.
- Create a new Project and set the project password (for simple setup you can use the same password you set in 4.4 Installation Wizard Step 4: frogBlue Mesh Setup).
- If you left the interface open proceed. If you locked the interface see section 20 Maintenance and Troubleshooting on resetting your frogTerminal.
- Choose + to add a device to frogProject and search for your frogTerminal via the Bluetooth MAC-Address.
- Once added select your Terminal from the device list and hit the config icon to write the settings (Do not select any setting parts to be replaced simply tap OK)
- Your frogTerminal is provisioned and ready for automation. Steps where frogMessages are available i.e. in Function PINs or Call Destinations now show the available frogMessages in their respective drop down menus..

17. Network Configuration

17.1. Ethernet or Wi-Fi Setup

Introduction:

Configure the network settings to connect the frogTerminal to your local network.

Steps Overview:

- Choose connection type (Ethernet or Wi-Fi).
- Configure IP settings (DHCP or static).
- Test network connectivity.

17.1.1. Network Configuration Via Web Browser.

Menu: System → Network

Not yet fully functional. Full Network setup via web browser coming soon via software update.

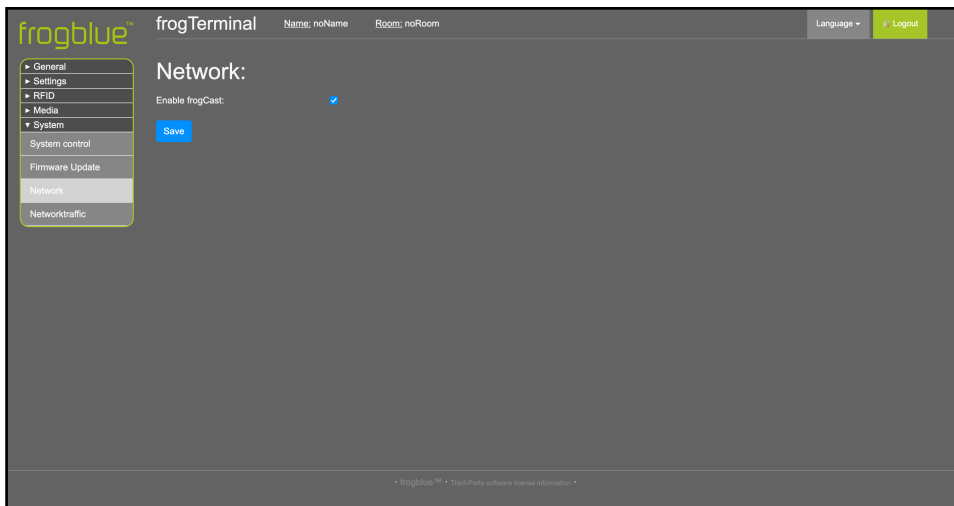

- Enable or disable frogCast via the checkbox.

17.1.2. Network Configuration Via On-Device Touch Screen.

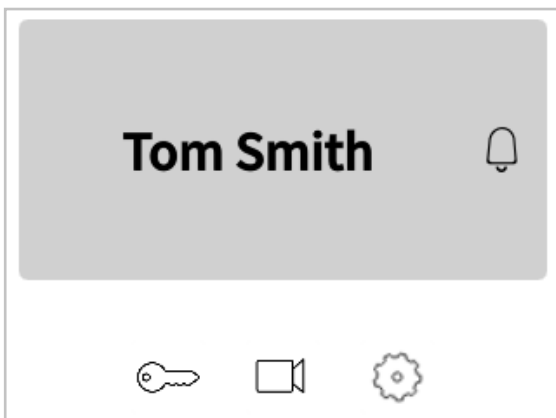

- Tap  to enter the configuration mode.



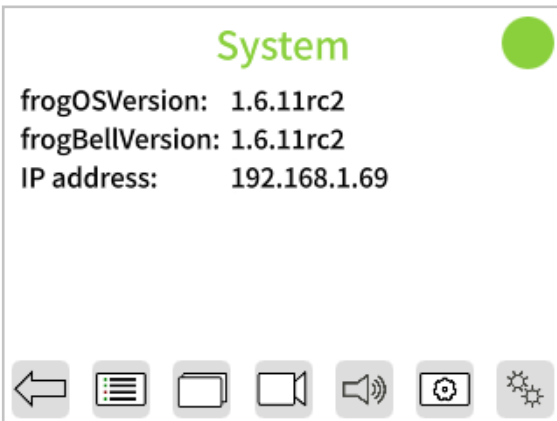

- Enter your **6-digit** Admin Pin and tap **OK** .





- Tap  to access the additional settings page.

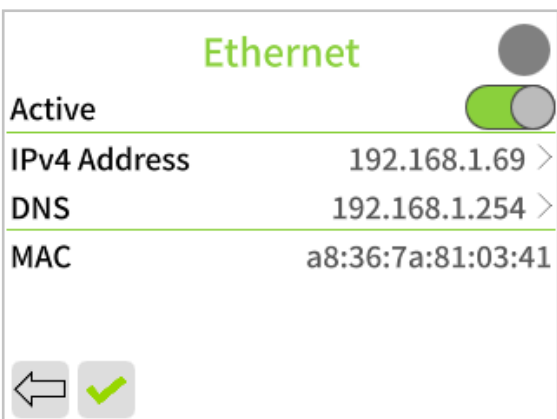

- Tap  to configure Ethernet Settings → Jump to Section 4.1.7
- Tap  to configure Wi-Fi Settings → Jump to Section 4.1.7

17.1.3. Ethernet Configuration Via On-Device Touch Screen.



- Leave active or deactivate Ethernet via the toggle switch if using Wi-Fi.
- Tap the lines to modify IPv4 address or DNS Settings.
- Tap  to return, or  to save changes and return to the Network Setup Page.

17.1.4. Wi-Fi Configuration Via On-Device Touch Screen.

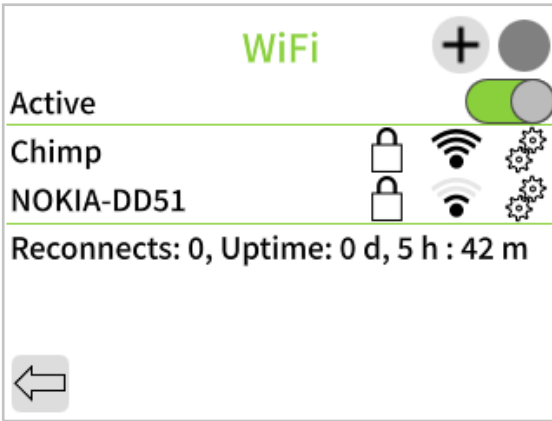

- Activate via the toggle switch if using Wi-Fi.
- Wait for the network list to populate – this may take a few minutes in complex setups.
- Tap on your preferred Wi-Fi Network or tap  to manually enter Wi-Fi details.

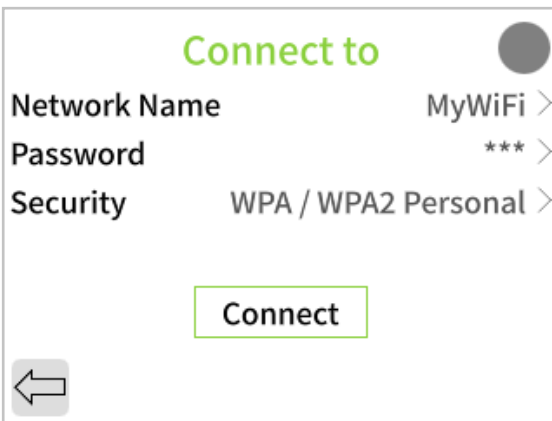

- For manual setup, tap and enter Network Name, Password, and Security mode.
- For a Network selected from the list enter the Password, & Security mode.
- Use the on-screen keyboard to enter the details and tap 'Ok'
- Finally, tap 'Connect.' If the first attempt fails, pause briefly and tap 'Connect' again.

17.1.5. Troubleshooting Network Connection Problems

Ethernet Connections:

- Ensure all cables are securely connected and undamaged.
- Test the Ethernet cable with another device to rule out cable issues.
- Verify the network port is active and properly configured.

Wi-Fi Connections:

- Move the device closer to the Wi-Fi router to improve signal strength.
- Check for obstacles or interference, such as walls or other electronic devices.
- Ensure the Wi-Fi credentials are entered correctly.

General Network Checks:

- Restart your router or access point.
- Verify the device is allowed on the network (e.g., MAC address filtering is disabled).
- Contact your administrator to ensure settings are correct and no restrictions are in place.

17.2. SIP Server Registration

Introduction:

This section explains how to register the terminal with a Session Initiation Protocol (SIP) server for telephony and intercom functionality. SIP registration enables the terminal to make and receive calls, integrate with VoIP systems, and support video calls.

Steps Overview:

- Single SIP server registration.
- Multiple SIP server registrations (multi-tenant scenarios).
- Testing SIP connectivity.

17.2.1. SIP Basics

Before proceeding with configuration, it's useful to understand some key SIP concepts:

- **SIP Server (Registrar Server):** The main server handling SIP registrations and authenticating devices. This is the **primary server address** where the terminal registers.
- **Outbound SIP Server (Proxy Server):** A secondary server used for routing outbound calls, often different from the registrar server. Some providers require a separate outbound server for call handling.
- **SIP Account (Username & Authorisation Username):**
 - **Username (SIP Extension):** The unique identifier assigned to the terminal (e.g., **1001** or **door@mybuilding.com**).
 - **Authorisation Username:** Some SIP providers require a separate **authorisation username** for login, which may differ from the SIP extension.
- **SIP URI (Uniform Resource Identifier):** The terminal's SIP address, formatted like an email (e.g., **sip:door@mybuilding.com**).
- **SIP Transport Protocols:** The method used to send SIP messages:
 - **UDP** (fastest but less reliable)
 - **TCP** (more reliable, better for NAT traversal)
 - **TLS** (encrypted and secure, recommended for VoIP security)
- **SIP Video Support:** If enabled, the terminal can transmit **real-time video** alongside audio calls using compatible codecs (e.g., H.264).

17.2.2. SIP Setup via Web Browser

Menu: Settings → SIP Server

Name	Username	Server	Outbound server	Authorization user name	Password	Transport protocol
frogTerminal1	frogterminal	sip.mysipserver.net	sip.mysipserver.net	frogterminal	*****	tls
frogTerminal1	u-92765	sip.companyb.net	sip.mysipserver.net	u-92765	*****	tcp
frogTerminal1	doorterminal	192.168.1.200	192.168.1.200	doorterminal	*****	udp

General Settings:

- **Allow direct call:** Check/uncheck to allow/deny direct IP calls at this Terminal without requiring any authentication via a SIP Server.

Warning! INSECURE: For testing or local (advanced) usage only. Use with caution as may result in malicious calls or call hijacking.

Primary Server:

- **Primary Server:** Determines the source of stored PIN codes for two-factor authentication, with 3 options:
 - **None:** Disables PIN entry at this terminal.
 - **Card:** The most common setting, enabling two-factor authentication with specific PIN codes assigned to individual users and stored on the access card.
 - **Terminal:** Secures the door or access point with a terminal-specific PIN code. This PIN applies to all users at this location, overriding personal PINs.

Selecting the Terminal option shows an additional input box enabling you to set a 6-digit PIN for access at this Terminal.

- **Time Table Source:** Specifies the source for time-based access rules, with 3 options:
 - **None:** Disables time-based access rules at this terminal.
 - **Card:** Time rules are stored on the access card, allowing individual schedules (e.g., General Staff: 9 a.m.-5 p.m., Cleaners: Fri-Sat 3 p.m.-7 p.m., Security: 24h).

- **Terminal:** Time rules are stored locally on the Terminal. Allowing each terminal to have an individual time-schedule as the source for time rules. Existing timetables on a accesscard will be ignored on this terminal.

17.3. Custom root certificates

Introduction: This section explains how to configure custom certificates on the frogTerminal for secure communication. The terminal allows you to upload a custom Root CA certificate, as well as a device certificate and private key in PEM format. This functionality is useful for environments requiring secure and private connections, particularly with internal networks or custom Certificate Authorities (CAs).

Steps Overview:

- Uploading a custom Root CA certificate.
- Uploading a device certificate and corresponding private key.
- Verifying certificate information.

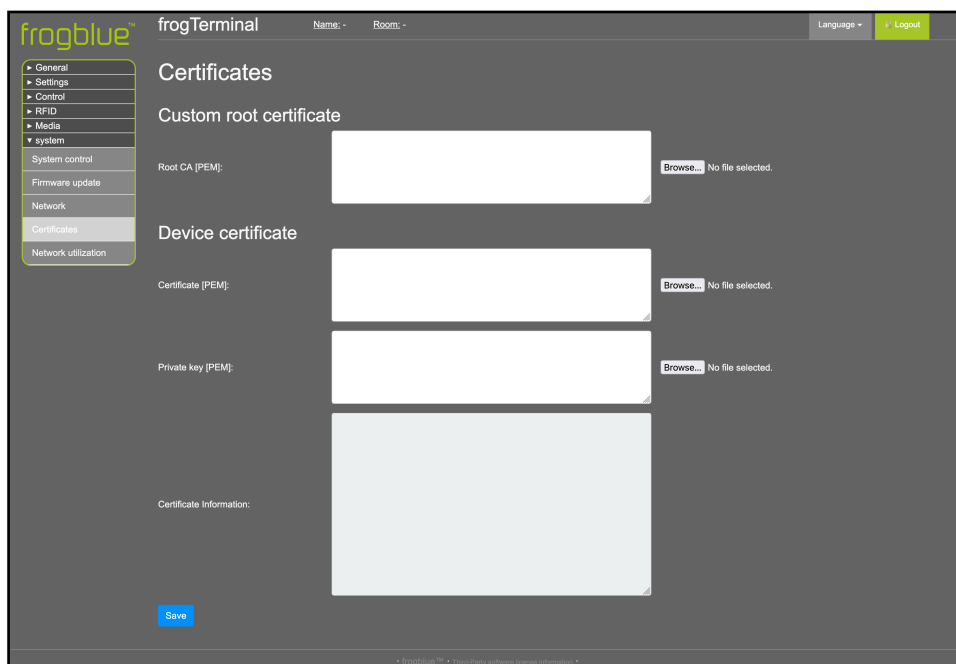

Custom Root Certificate:

The **Root CA (PEM)** field allows you to upload a custom root certificate in PEM format. This is used to authenticate server or peer certificates for secure communication.

Use cases:

- Integrating with private or internal CAs.
- Enabling secure API calls or encrypted communication in private networks.

How to upload:

- Click **Browse** next to the Root CA (PEM) field.
- Select the appropriate PEM file containing your Root CA certificate and click **Open**.
- Click **Save** to apply your custom root certificate.

Device Certificate:

- The **Certificate (PEM)** field allows you to upload the device's unique certificate for identification and authentication.
- The **Private Key (PEM)** field allows you to upload the private key associated with the device certificate.

Use cases:

- Secure mutual authentication with servers (e.g., in TLS handshakes).
- Enabling encrypted communication between devices and servers.

How to upload:

- Click **Browse** next to the Certificate (PEM) field and select the device certificate file and click **Open**.
- Click **Browse** next to the Private Key (PEM) field and select the private key file and click **Open**.
- Ensure both files are correctly paired and valid.

Certificate Information:

- The **Certificate Information** field provides a summary of the uploaded device certificate, including details such as the certificate's issuer, validity period, and subject.
- Verify this information to ensure the certificate has been uploaded and recognised correctly.

Important Notes:

- Ensure all files are in **PEM format** before uploading. Unsupported file formats will result in errors.
- Uploading incorrect or invalid certificates may cause connectivity issues or disrupt communication.
- For private networks or custom applications, consult your system administrator for the correct certificates.
- Certificates and private keys must be securely stored and handled to prevent unauthorized access.

18. Integration with Third-Party Video Systems

Integrate the terminal with external video streaming or management systems.

18.1. HTTPS or Web Integration - Plain MJPEG stream

The **frogTerminal** supports an **MJPEG stream** or **Fast-Stream** over **HTTPS** for compatibility with legacy systems or simple integration into websites. **HTTPS authentication** is required and can be passed in standard HTTP format, for example:

- **Basic URL:** `https://<IP Address>/cgi-bin/cam.cgi`
- **With Authentication:** `https://<username>:<password>@<IP Address>/cgi-bin/cam.cgi`

18.2. RTSP Settings

Menu: System → RTSP Settings

The **frogTerminal** supports the **Real-Time Streaming Protocol (RTSP)** for **integrating** its camera video stream into **third-party video systems**. Audio support is currently in development.

RTSP is a widely adopted streaming protocol that allows clients to request, control, and receive real-time video feeds from IP cameras and media servers. It serves as the underlying protocol for **ONVIF** (Open Network Video Interface Forum), the industry standard for interoperability between IP-based security devices. ONVIF support for the **frogTerminal** is currently in development.

Many popular Video Management Systems (VMS), such as **Milestone XProtect** and **Genetec Security Center**, support **direct RTSP stream integration**, allowing the **frogTerminal** to be added as a video source without requiring additional drivers or plugins.

RTSP Stream URL Format

To access the RTSP stream from the **frogTerminal**, use the following URL format:

`rtsp://<username>:<password>@<IP Address>:<port>/cam`

- **<username>:** The designated RTSP user (**rtsp**) or an admin user.
- **<password>:** The password for the RTSP user or an admin account.
- **<IP Address>:** The local or external IP of the **frogTerminal**.
- **<port>:** The RTSP service port (**default: 554**, unless changed in the configuration).
- **/cam:** The RTSP stream path.

Optimal Settings for Low Latency & High Frame Rate

To achieve the best low-latency performance and high frame rate, ensure that:

- **No browser-based HTTPS or web stream** is running (e.g., camera live stream in a browser).
- The following **image settings** are applied:
 - **Image Enhancement:** Set to Off.
 - **Image Resolution:** Set to maximum HD.
 - **JPEG Compression Quality:** Set to 60%.

- **On-board recording is disabled** for optimal performance. Instead, use a **VMS system** for video recording.

User Access:

- The dedicated **RTSP user (rtsp)** can be used **exclusively for RTSP streaming**.
- **Admin users** can also access the RTSP stream using their credentials.

Additional Notes

- Ensure that **RTSP is enabled** on the frogTerminal and that firewall rules allow traffic on the specified RTSP port.
- For **remote access**, port forwarding or a **VPN connection** may be required, depending on the network setup.
- **ONVIF support is planned**, which will enable further integration with automated VMS discovery and additional video security platforms.
- **Latency and stream stability** depend on network conditions and encoding settings.

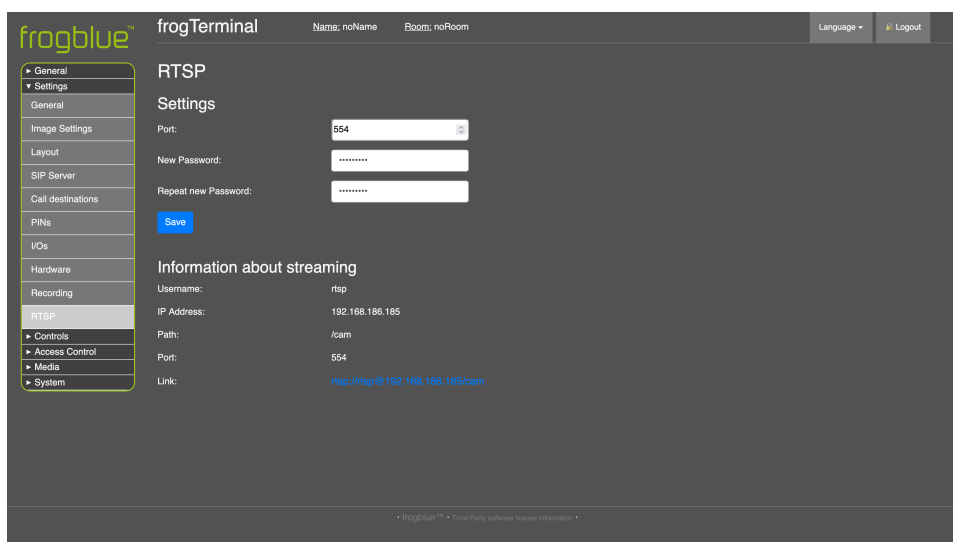

Port

- Defines the port used for the RTSP streaming service.
- Default: 554 (standard RTSP port).
- If your network requires a different port, enter the desired custom port number.
- Ensure that the selected port is open in your firewall/router if accessing the stream remotely.

New Password

- Set a new password for the RTSP user (rtsp).
- This is a dedicated password for connecting to the stream using the RTSP URL.

- **Minimum Requirements:** At least 8 characters, including a mix of uppercase, lowercase, and numbers for security.

Repeat New Password

- Re-enter the new password to confirm it.

Save

- Saves the **updated port and password settings**.
- Changes will take effect immediately after saving.
- After saving, update your **RTSP settings** in **external applications** if you changed the password or port.

18.3. RTSP Stream Integration

This section provides step-by-step instructions on how to integrate the frogTerminal RTSP stream with OBS Studio and VLC Media Player.

Ensure that:

RTSP is enabled on the frogTerminal.

The correct RTSP URL is used:

RTSP Integration with VLC Media Player

VLC Media Player is an open-source video player that supports **RTSP streaming**. To integrate the frogTerminal RTSP stream into VLC:

- Open **VLC Media Player**.

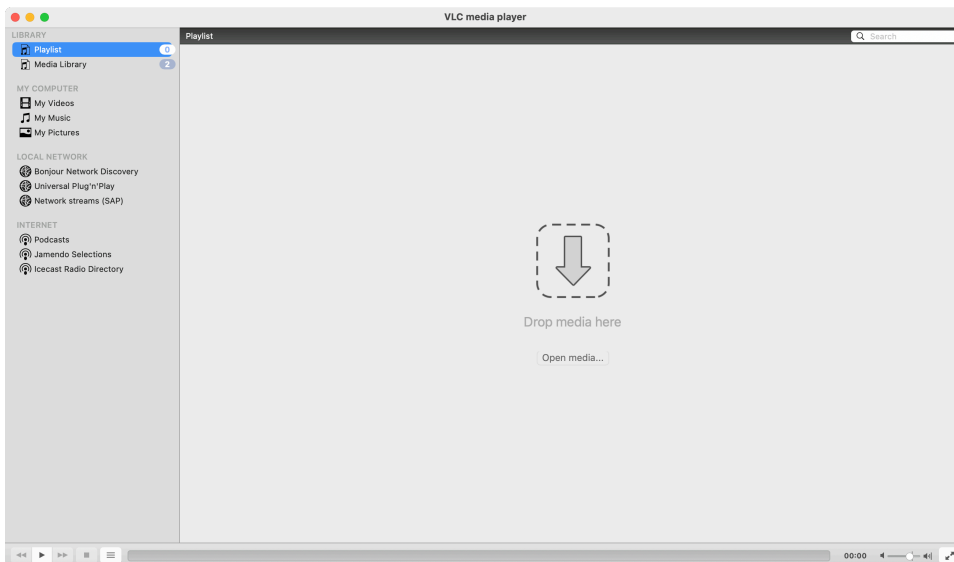

- Click **Open Media**.

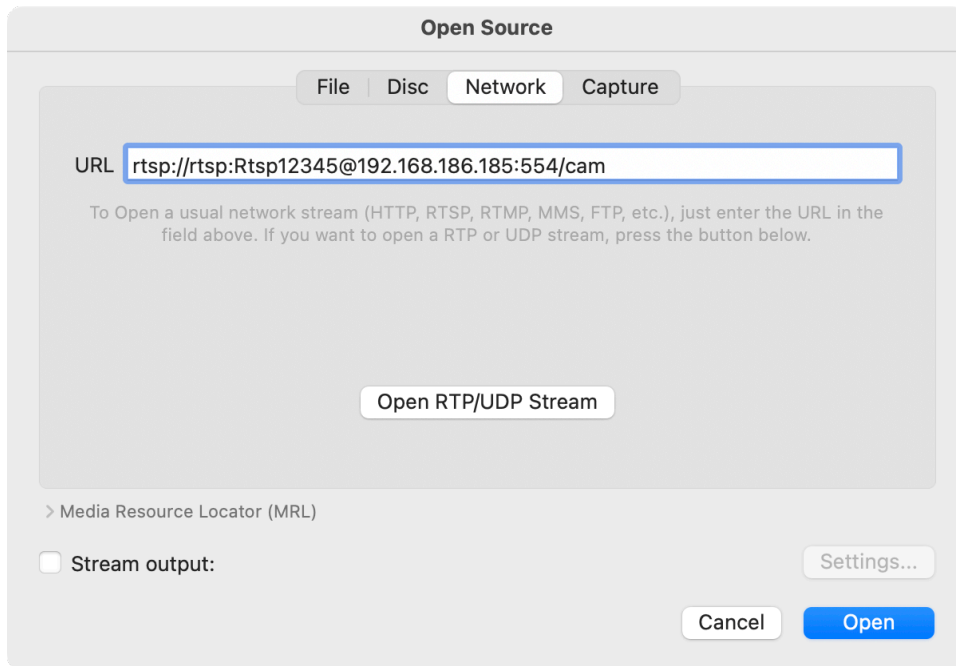

- Go to → **Network**.
- Enter the **RTSP URL**. The username and password can be passed in HTTP format as per the example or entered at the next step.



The camera stream should now appear in the VLC main window. By default, VLC will buffer the stream, which may introduce a delay of several seconds.

VLC is primarily designed for **streaming over the internet** and includes built-in buffering mechanisms that may **increase latency**, which may affect real-time performance. To optimise VLC for **low-latency streaming**, adjustments to buffering settings may be required.

RTSP Integration with OBS Studio streaming and recording software

OBS Studio is a widely used open-source streaming and recording tool. Follow these steps to integrate the frogTerminal RTSP stream into OBS:

- Open OBS Studio.

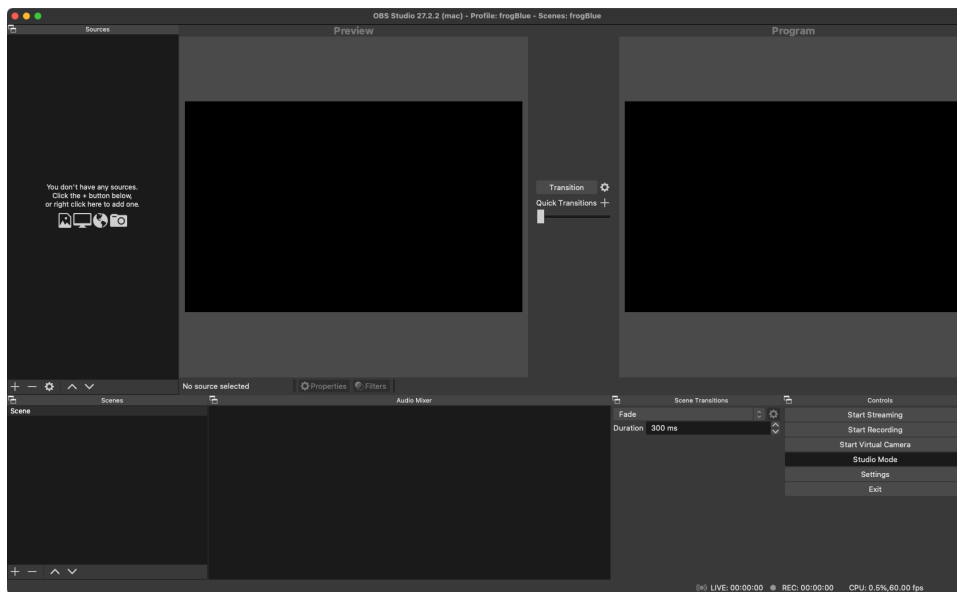

- Click + under **Sources** to add a new video source.

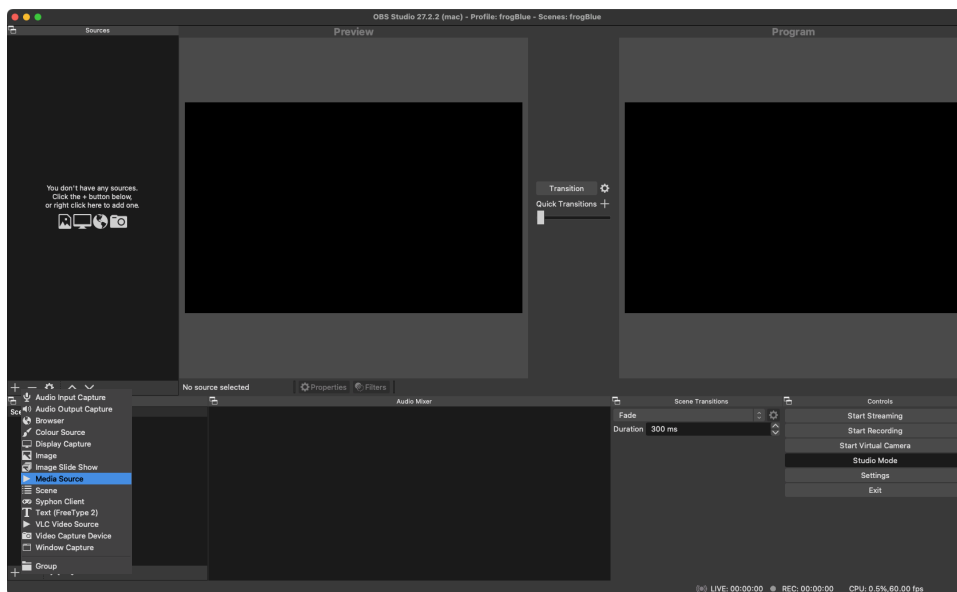

- Choose ► **Media Source**

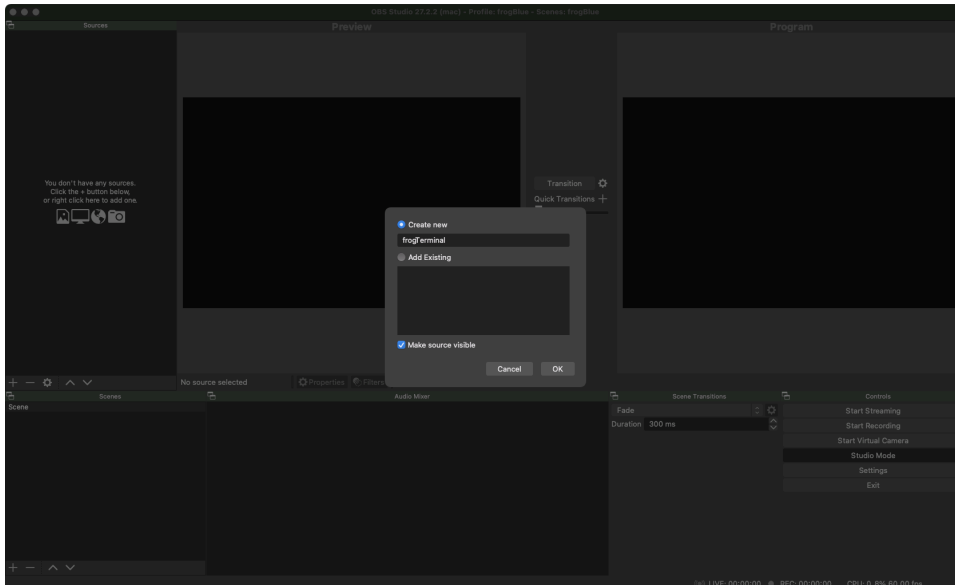

- Give your source a name i.e. **"frogTerminal"**
- Click **OK**

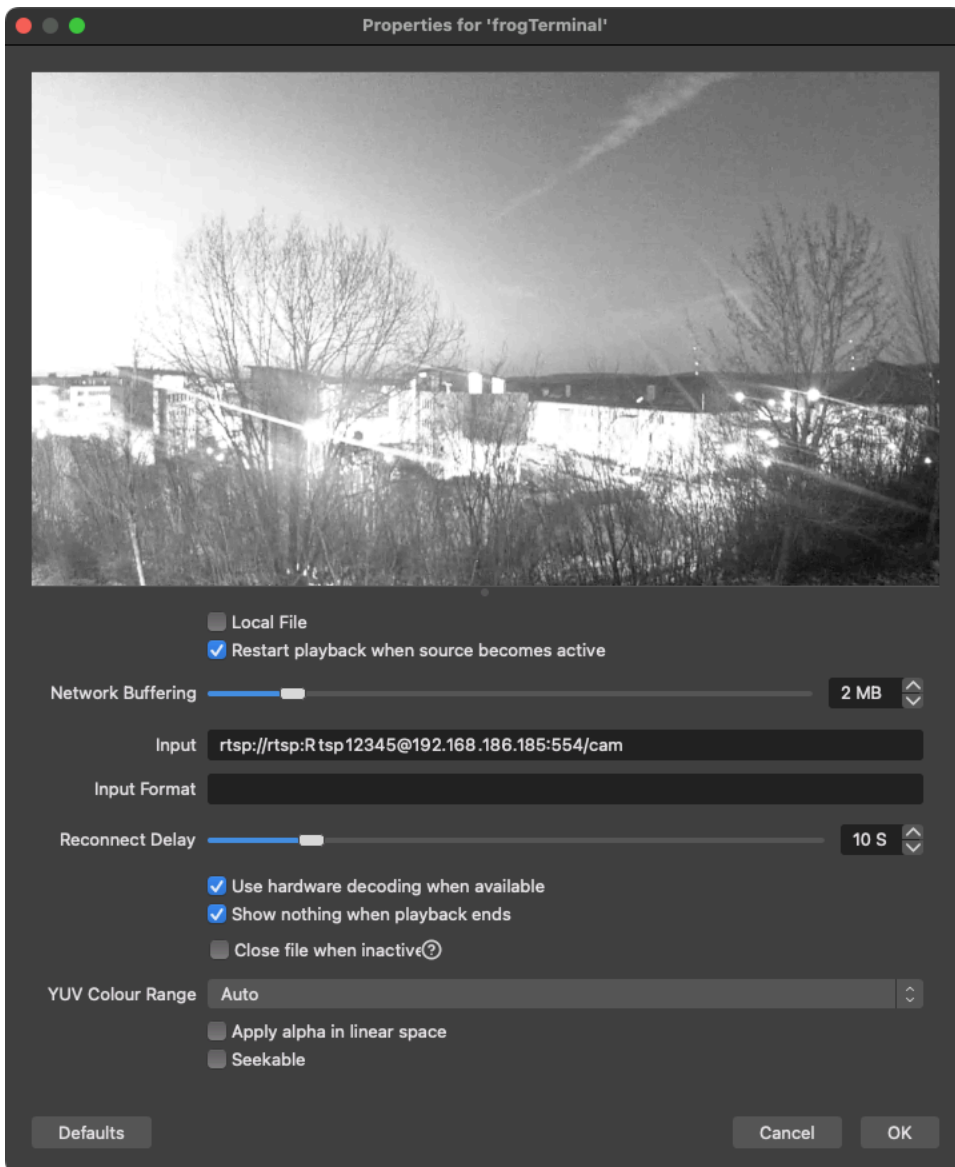

- Untick **Local File**
- **Input:** Enter the **RTSP URL**. The username and password can be passed in HTTP format as per the example or entered at the next step.
- Tick **Use hardware decoding when available**
- Click **OK**

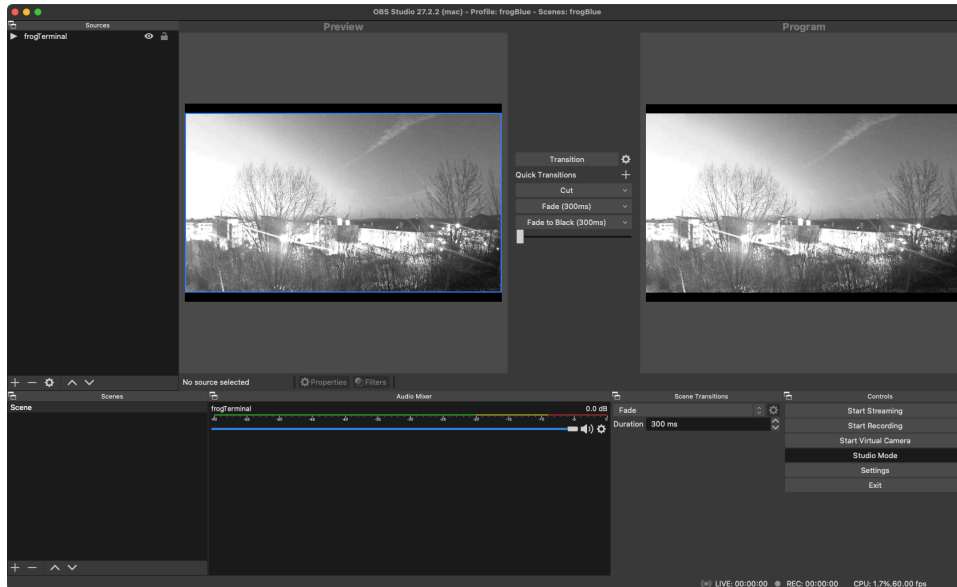

The frogTerminal camera livestream should now be visible in OBS Studio.

Note: On some **operating systems or OBS versions**, you may receive a **popup window** requesting permission to allow **OBS Studio** access to your **network** or through your **firewall**. Ensure that you **confirm or allow** this access to enable the stream.

Additionally, on certain systems, **OBS Studio may need to be restarted** after completing the setup and acknowledging any popups. If the stream does not appear immediately, try **closing and reopening OBS Studio**.

18.4. Integration with MOBOTIX MxManagementCenter

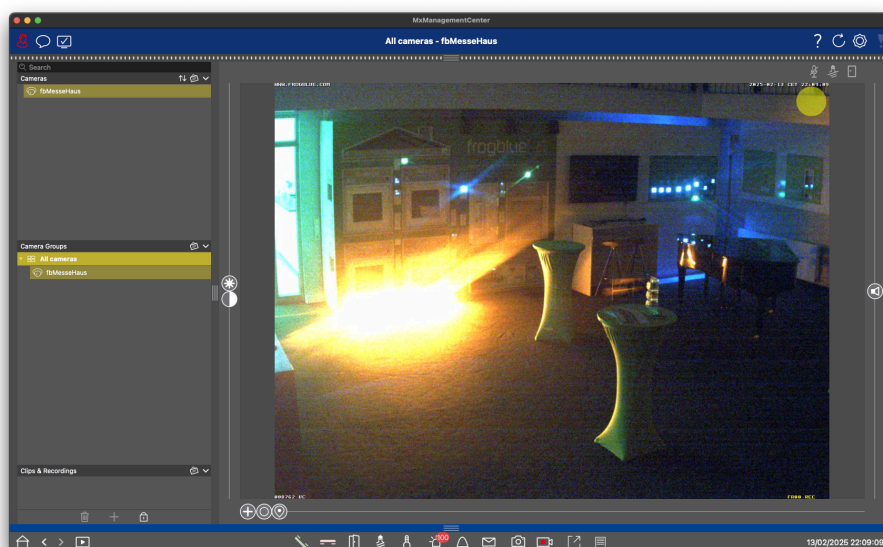

- Click on the Lock Symbol at the bottom of the left sidebar to unlock the interface.

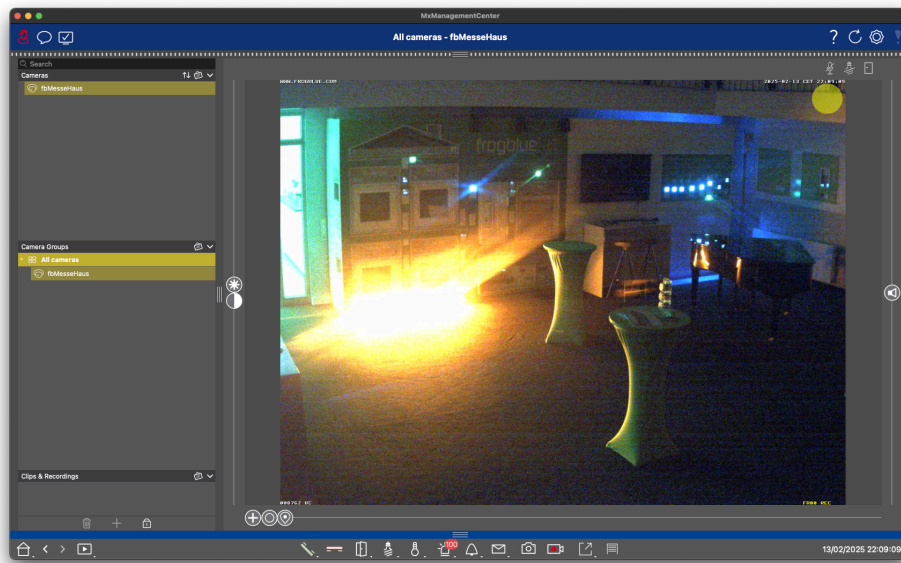

- Click on the + Symbol at the bottom of the left sidebar to add a new element.

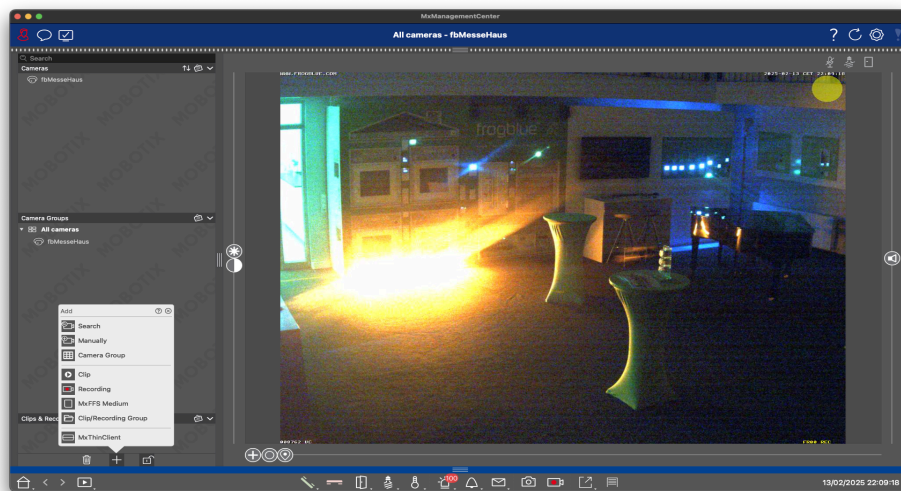

- Click on the + Manually Symbol to add a new camera source.

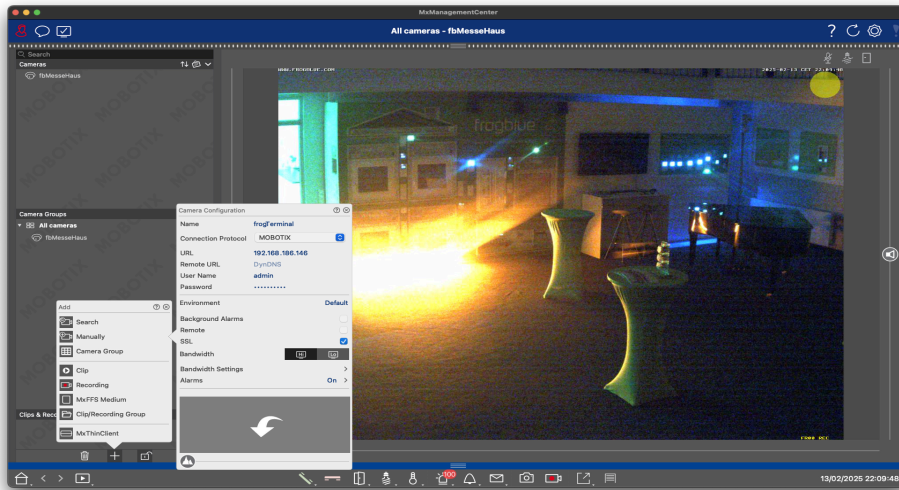

- Name: Enter a name in MxCC for your frogTerminal.
- Connection Protocol: Select "MOBOTIX".
- URL: Input the IP Address of your frogTerminal.
- User Name: Input the web username for your frogTerminal.
- Password: Input the web password for your frogTerminal.
- SSL: Tick the box to enable secured connection to your frogTerminal (required).
- Click out of the settings boxes area i.e. on the grey left sidebar area.

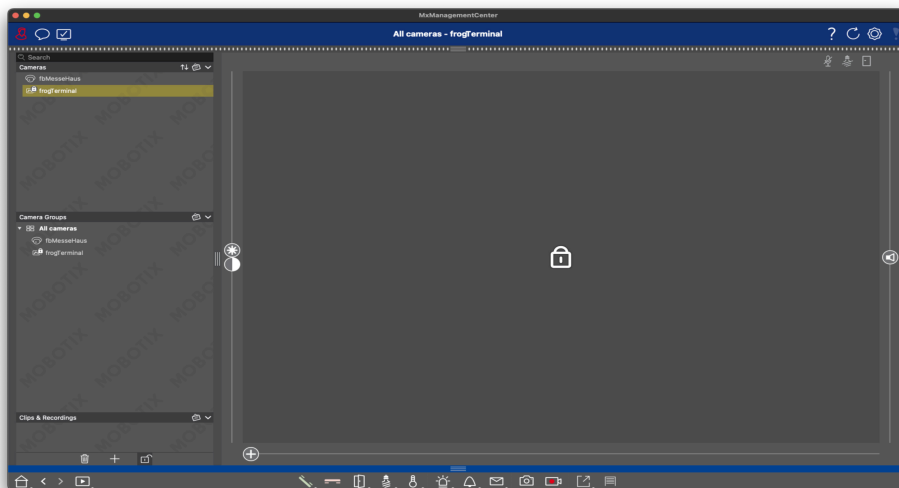

- Click on the Refresh Arrow Symbol top-right of the interface.

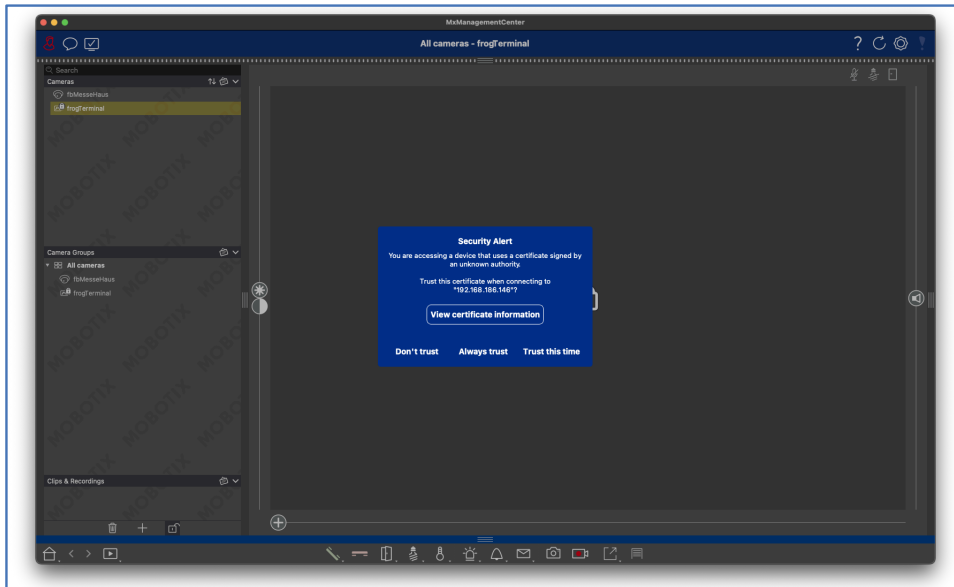

- Click "Always Trust" or "Trust this Time" to accept the connection.

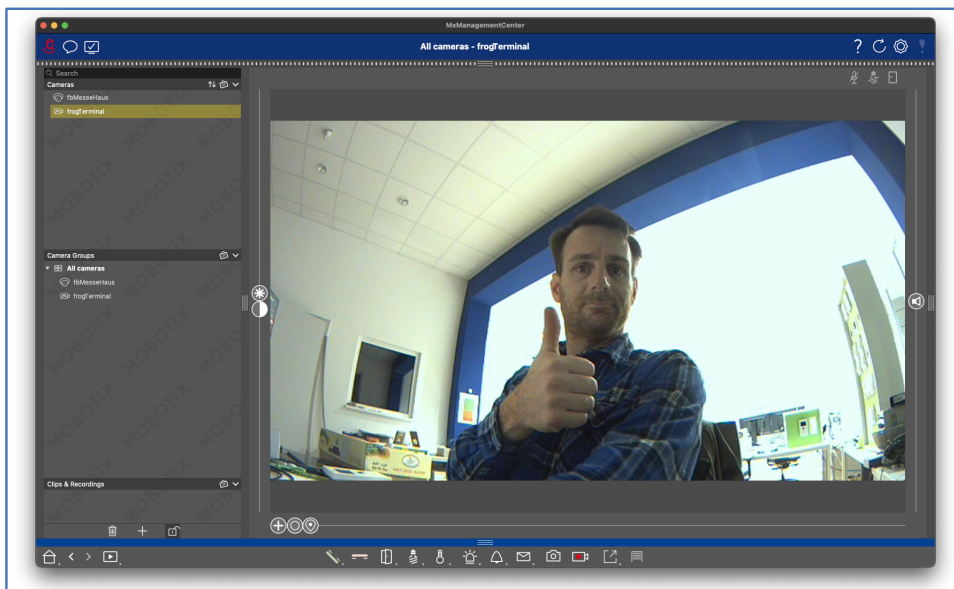

- The frogTerminal video stream should appear in MxMC

19. Advanced Integration and API Features

Special Features! Talk to your frogblue Partner or local frogblue Competence Center for details.

19.1. Custom Display Interfaces

Customise your frogTerminal's user interface to achieve stunning designs and next-level integrations. This high-quality smart door station access control interface is the ideal solution to elevate your system or SaaS offering, delivering both enhanced aesthetics and advanced functionality.

19.2. Time Tracking and Attendance

Leverage the frogTerminal to streamline staff time tracking. Configure simple check-in, break, and check-out options, and export attendance logs to your preferred workforce management system for efficient record-keeping.

Examples applications include:

Logistics: Notify warehouse automation systems to prepare or dispatch an order upon access. Automatically light a path to the delivery gate for efficient navigation.

Healthcare: Trigger nurse call or management systems to log patient visitor details or confirm the delivery of critical medication including QR code verification to ensure the right medication is given to the right person.

Building Automation: Activate lighting and adjust HVAC settings along a defined route for the user, or automatically call an elevator to the correct floor.

20. Maintenance and Troubleshooting

20.1. Firmware Updates

Introduction:

Keep the terminal up to date with the latest features and security patches.

20.2. System Control - Manage configuration files, Reboot, and Factory Reset

Introduction:

This section details how to download or upload the entire configuration, reboot the system, or reset the device to factory defaults.

1 Reset system to factory defaults via Web interface

Menu: System → System Control

To perform a factory reset, click "Reset to Factory Defaults" and then "Yes" to confirm. Wait until you see the message "Done" in the browser and the Terminal screen returns to the Welcome page with the Start Wizard option. Please note that the reset process may take several minutes to clear all logs and recordings. For best results, allow sufficient time and perform a reboot or power cycle after the reset.

Via On-screen interface

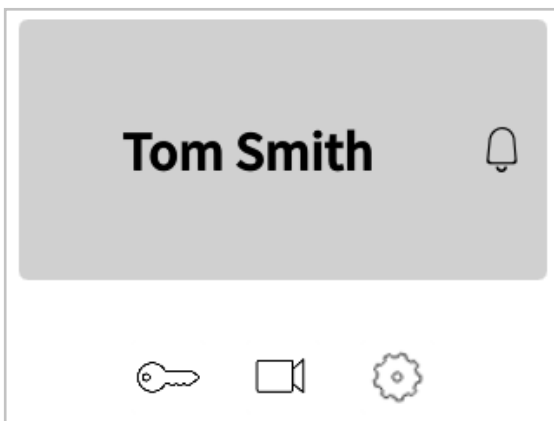

- Tap  to enter the configuration mode.



- Enter your **6-digit** Admin Pin and tap  .

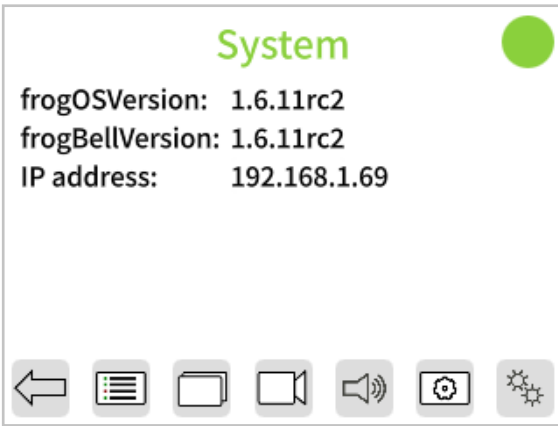

- Tap  to access the additional settings page.



- Tap  to enter the system reset and reboot menu.



A hard reset can be performed with the frogProject App when all PINS & Passwords forgotten. Reach out to your frogblue Partner or local frogblue Competence Center for support.

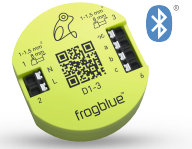

We wirelessly link lights, blinds, fans, windows, doors, heating, intercoms, and standard light switches via **Bluetooth®**.

Our frogs are installed behind conventional light switches/outlets and only require 110..240V mains. Control wiring is not required as connections are made virtually.

A single app controls the entire house, either locally via Bluetooth® or worldwide from a smartphone. Frogblue is effortlessly installed without a server or switch cabinet and is child's play to configure.

Our intercom, **frogTerminal**, supports the universal SIP telephony standard, making it fully multi-tenant capable. Together with the integrated RFID reader and a PIN, it enables a decentralised access solution with 3-factor authentication.

Our major strengths are the **reliability and security** of a mature system that can be adapted to the users needs even years later.

Remark: User interfaces of wall display, frogTerminal and apps are available in more than twenty languages!

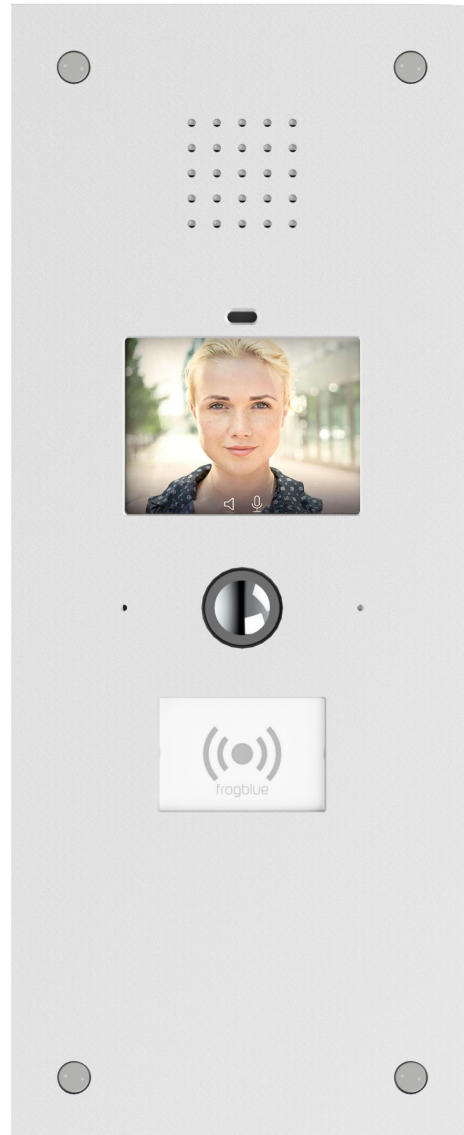

Copyright 2025, fb Vertriebs AG

All rights reserved. Texts, images, and graphics are protected by copyright law. The content of this brochure may not be copied, distributed, or altered. For binding technical data, please refer to our system manual. Specifications are subject to change. Frogblue and the logo are registered trademarks of fb Vertriebs AG.

